



Listino Prezzi  
Price List  
Tarifa  
Tarif

Waterworks

2015



Customer	Date
Discounts	
Stamp/Signature	Validity

ISO Certified Quality Management System



## HYDROMODUL®

*Valvole Idrauliche a Semplice Camera*  
*Single Chamber Hydraulic Valves*  
*Válvulas Hidráulicas de Simple Cámara*  
*Vanne Hydrauliques à Simple Chambre*

Pag.01-08



## HYDROMODUL® -D / -P

*Valvole Idrauliche a Doppia Camera e a Pistone*  
*Double Chamber & Piston Hydraulic Valves*  
*Válvulas Hidráulicas de Doble Cámara y de Pistón*  
*Vanne Hydrauliques à Double Chambre et à Pistón*

Pag.09-12

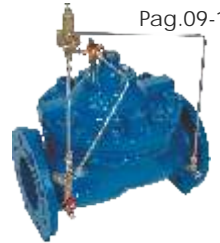

## IDROMEMBRANA®

*Valvole Idrauliche a Membrana (metalliche)*  
*Diaphragm Hydraulic Valves (metallic)*  
*Válvulas Hidráulicas de Membrana (metálicas)*  
*Vanne Hydrauliques à Membrane (metalliques)*

Pag.13-18



## IDROMEMBRANA® - VHF

*Valvole Idrauliche a Membrana (plastica)*  
*Diaphragm Hydraulic Valves (plastic)*  
*Válvulas Hidráulicas de Membrana (plástico)*  
*Vanne Hydrauliques à Membrane (plastique)*

Pag.19-22



## CONTATORI

*Contatori per Acqua*  
*Water Meters*  
*Medidores de Agua*  
*Compteurs d'Eau*

Pag.23-24



## SEZIONAMENTO

*Saracinesche, Sfiati, Filtri e Valvole di Ritegno*  
*Gate Valves, Air Vents, Strainers & Check Valves*  
*Compuertas, ventosas, Filtros y Válvulas de Retención*  
*Vannes Opercule, Ventouses, Filtres et Vannes Anti-rétour*

Pag.25



## REGOLAZIONE

*Valvole di Regolazione a Farfalla e a Fuso*  
*Regulating Butterfly & Needle Valves*  
*Válvulas de Regulación de Mariposa y Anulares*  
*Vannes de Régulation à Papillon et Annulaires*

Pag.26



# Hydraulic Control Valves

PN 16/25/40

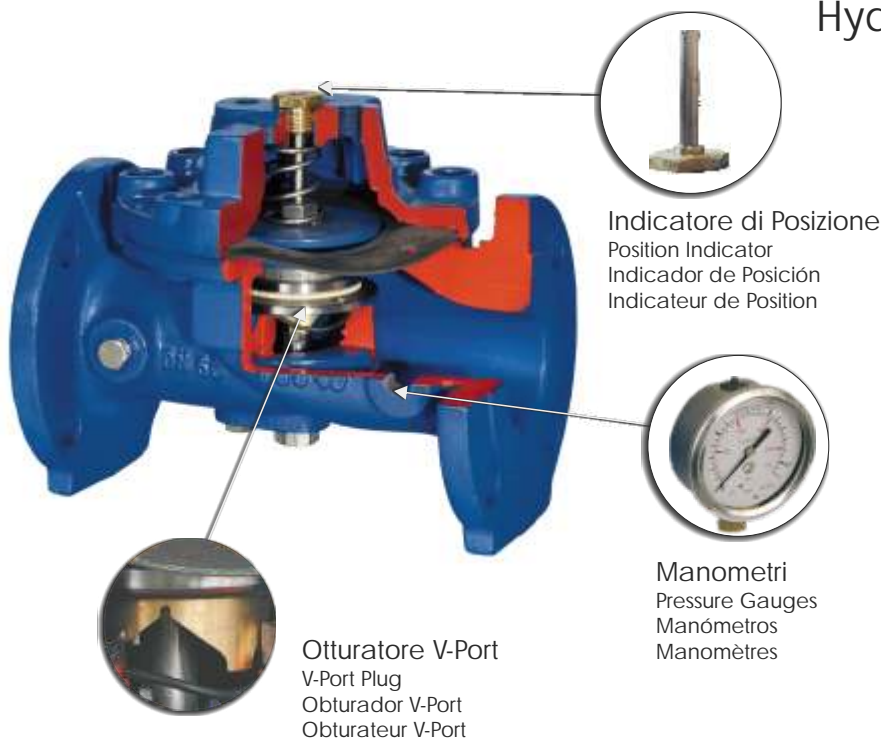

HM  
Single Chamber



HM-D  
Double Chamber



HM-P  
Piston  
(Proportional)

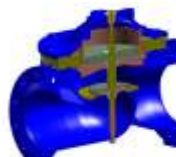

## Dimensioni & Pesì / Dimensions & Weights / Dimensiones y Pesos / Dimensions et Poids

Ø (Inch)	L (mm)	H (mm)	B (mm)	P (Kg)	Q <sub>n</sub> (*)	
					ON-OFF (m <sup>3</sup> /h)	REG. (m <sup>3</sup> /h)
1"1/4	230	195	165	17	22	44
1"1/2	290	205	185	20	26	52
2"	310	270	200	33	37	74

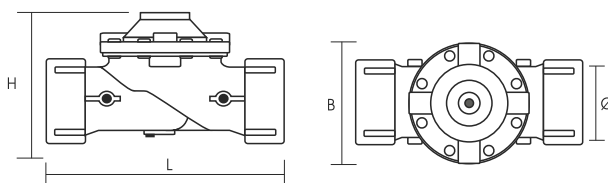

Ø (mm-inch)	L (mm)	H (mm)	B (mm)	P (Kg)	Q <sub>n</sub> (*)	
					ON-OFF (m <sup>3</sup> /h)	REG. (m <sup>3</sup> /h)
50 - 2"	230	195	165	17	22	44
65 - 2"1/2	290	205	185	20	26	52
80 - 3"	310	270	200	33	37	74
100 - 4"	350	290	235	35	58	116
125 - 5"	400	320	270	48	86	172
150 - 6"	480	390	300	80	125	250
200 - 8"	600	460	360	180	195	390
250 - 10"	730	495	425	200	415	830
300 - 12"	850	700	485	460	720	1440
350 - 14"	980	700	555	530	800	1600
400 - 16"	1100	920	620	960	910	1820
500 - 20"	1250	980	730	1400	1350	2700
600 - 24"	1450	1035	845	1750	1650	3300
700 - 28"	1650	1325	910	2600	3300	6600
800 - 32"	1850	1385	1025	3000	3750	7500
900/1000/1200 - 36"/40"/48"				Su richiesta / On demand / Sobre demanda / Sur demande		

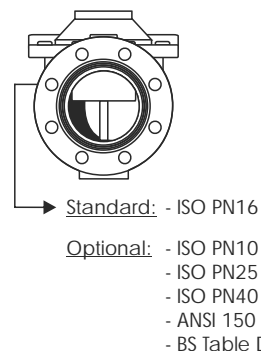
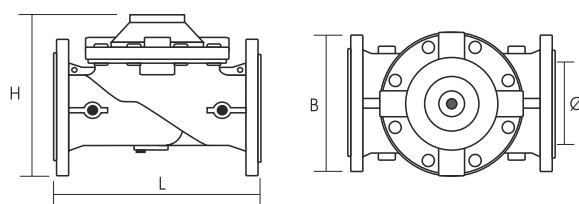
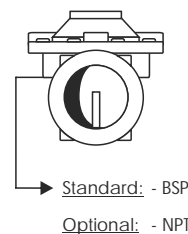

(\*) Portate Nominali / Nominal Flow Rates / Caudales Nominales / Débits Nominales

Q<sub>n</sub> [ON-OFF] → DP = 0.2 (bar)

Q<sub>n</sub> [REG.] → DP = 0.8 (bar)

ООО «ТИ-СИСТЕМС» ИНЖИНИРИНГ И ПОСТАВКА ТЕХНОЛОГИЧЕСКОГО ОБОРУДОВАНИЯ

Интернет: www.tisys.ru www.tisys.kz www.tisys.by www.tesec.ru www.ti-sistems.pl

PN16	COD.	Ø		Euro
		mm	inch	
FLANGED BRIDES	HMARP2M16050F	50	2"	1.272,00
	HMARP2M16065F	65	2½"	1.353,00
	HMARP2M16080F	80	3"	1.582,00
	HMARP2M16100F	100	4"	1.982,00
	HMARP2M16125F	125	5"	2.499,00
	HMARP2M16150F	150	6"	2.762,00
	HMARP2M16200F	200	8"	4.596,00
	HMARP2M16250F	250	10"	6.843,00
	HMARP2M16300F	300	12"	8.724,00
	HMARP2M16350F	350	14"	12.162,00
	HMARP2M16400F	400	16"	16.026,00
	HMARP2M16500F	500	20"	23.822,00
	HMARP2M16600F	600	24"	33.475,00
FLANGIATO BRIDADO	Ø 700-800 (28"-32")	-----		
	Ø 900-1000-1200 (36"-40"-48")	-----		

PN25	COD.	Ø		Euro
		mm	inch	
FLANGED BRIDES	HMARP2M25050F	50	2"	1.399,00
	HMARP2M25065F	65	2½"	1.488,00
	HMARP2M25080F	80	3"	1.740,00
	HMARP2M25100F	100	4"	2.180,00
	HMARP2M25125F	125	5"	2.749,00
	HMARP2M25150F	150	6"	3.038,00
	HMARP2M25200F	200	8"	5.056,00
	HMARP2M25250F	250	10"	7.527,00
	HMARP2M25300F	300	12"	9.596,00
	HMARP2M25350F	350	14"	13.378,00
	HMARP2M25400F	400	16"	17.629,00
	HMARP2M25500F	500	20"	26.204,00
	HMARP2M25600F	600	24"	36.823,00
FLANGIATO BRIDADO	Ø 700-800 (28"-32")	-----		
	Ø 900-1000-1200 (36"-40"-48")	-----		



HM-RP2M

Standard Options



1,0÷11,0 bar 2,0÷23,0 bar  
PN25  
2-way

PN16	COD.	Ø		Euro
		mm	inch	
FILETTATO THREADED ROSCADO TARAUDÉ	HMARP2M16114M	32	1¼"	1.031,00
	HMARP2M16112M	40	1½"	1.145,00
	HMARP2M1602"M	50	2"	1.145,00

PN25	COD.	Ø		Euro
		mm	inch	
FILETTATO THREADED ROSCADO TARAUDÉ	HMARP2M25114M	32	1¼"	1.031,00
	HMARP2M25112M	40	1½"	1.145,00
	HMARP2M2502"M	50	2"	1.145,00

Funzioni Aggiuntive / Additional Functions / Funciones Adicionales / Fonctions Supplémentaires



HM-RP2M + E2 Solenoide 2 vie / 2-way solenoid / Solenoide de 2 vias / Solenoide 2 voies (24V AC PN16)

Euro 119,00

Sostegno Pressione / Pressure Sustaining / Sostenedoras de Presión / Mainteneur de Pression

PN16	COD.	Ø		Euro
		mm	inch	
FLANGED BRIDES	HMASP2M16050F	50	2"	1.386,00
	HMASP2M16065F	65	2½"	1.467,00
	HMASP2M16080F	80	3"	1.696,00
	HMASP2M16100F	100	4"	2.098,00
	HMASP2M16125F	125	5"	2.614,00
	HMASP2M16150F	150	6"	2.877,00
	HMASP2M16200F	200	8"	4.711,00
	HMASP2M16250F	250	10"	6.958,00
	HMASP2M16300F	300	12"	8.929,00
	HMASP2M16350F	350	14"	12.361,00
	HMASP2M16400F	400	16"	16.210,00
	HMASP2M16500F	500	20"	24.006,00
	HMASP2M16600F	600	24"	33.658,00
FLANGIATO BRIDADO	Ø 700-800 (28"-32")	-----		
	Ø 900-1000-1200 (36"-40"-48")	-----		

PN25	COD.	Ø		Euro
		mm	inch	
FLANGED BRIDES	HMASP2M25050F	50	2"	1.525,00
	HMASP2M25065F	65	2½"	1.614,00
	HMASP2M25080F	80	3"	1.866,00
	HMASP2M25100F	100	4"	2.308,00
	HMASP2M25125F	125	5"	2.875,00
	HMASP2M25150F	150	6"	3.165,00
	HMASP2M25200F	200	8"	5.182,00
	HMASP2M25250F	250	10"	7.654,00
	HMASP2M25300F	300	12"	9.822,00
	HMASP2M25350F	350	14"	13.596,00
	HMASP2M25400F	400	16"	17.831,00
	HMASP2M25500F	500	20"	26.407,00
	HMASP2M25600F	600	24"	37.024,00
FLANGIATO BRIDADO	Ø 700-800 (28"-32")	-----		
	Ø 900-1000-1200 (36"-40"-48")	-----		



HM-SP2M

Standard Options



1,0÷10,0 bar 2,0÷23,0 bar  
PN25  
2-way

PN16	COD.	Ø		Euro
		mm	inch	
FILETTATO THREADED ROSCADO TARAUDÉ	HMASP2M16114M	32	1¼"	1.122,00
	HMASP2M16112M	40	1½"	1.247,00
	HMASP2M1602"M	50	2"	1.247,00

PN25	COD.	Ø		Euro
		mm	inch	
FILETTATO THREADED ROSCADO TARAUDÉ	HMASP2M25114M	32	1¼"	1.122,00
	HMASP2M25112M	40	1½"	1.247,00
	HMASP2M2502"M	50	2"	1.247,00

Funzioni Aggiuntive / Additional Functions / Funciones Adicionales / Fonctions Supplémentaires



HM-SP2M + E2 Solenoide 2 vie / 2-way solenoid / Solenoide de 2 vias / Solenoide 2 voies (24V AC PN16)

Euro 119,00

ООО «ТИ-СИСТЕМС» ИНЖИНИРИНГ И ПОСТАВКА ТЕХНОЛОГИЧЕСКОГО ОБОРУДОВАНИЯ

Интернет: www.tisys.ru www.tisys.kz www.tisys.by www.tesec.ru www.ti-sistems.pl



HM-SR

Standard Options  
1,0 ÷ 10,0 bar 1,5 ÷ 22,0 bar  
PN25



PN16	COD.	Ø		Euro
		mm	inch	
FLANGED BRIDES	HMASR0016050F	50	2"	1.318,00
	HMASR0016065F	65	2½"	1.398,00
	HMASR0016080F	80	3"	1.628,00
	HMASR0016100F	100	4"	2.029,00
	HMASR0016125F	125	5"	2.545,00
	HMASR0016150F	150	6"	2.808,00
	HMASR0016200F	200	8"	4.678,00
	HMASR0016250F	250	10"	6.924,00
	HMASR0016300F	300	12"	9.079,00
	HMASR0016350F	350	14"	12.519,00
FLANGIATO BRIDADO	HMASR0016400F	400	16"	16.302,00
	HMASR0016500F	500	20"	24.097,00
	HMASR0016600F	600	24"	33.749,00
	Ø 700-800 (28"-32")			-----
	Ø 900-1000-1200 (36"-40"-48")			-----

PN25	COD.	Ø		Euro
		mm	inch	
FLANGED BRIDES	HMASR0025050F	50	2"	1.450,00
	HMASR0025065F	65	2½"	1.538,00
	HMASR0025080F	80	3"	1.791,00
	HMASR0025100F	100	4"	2.232,00
	HMASR0025125F	125	5"	2.800,00
	HMASR0025150F	150	6"	3.089,00
	HMASR0025200F	200	8"	5.146,00
	HMASR0025250F	250	10"	7.616,00
	HMASR0025300F	300	12"	9.987,00
	HMASR0025350F	350	14"	13.711,00
FLANGIATO BRIDADO	HMASR0025400F	400	16"	17.932,00
	HMASR0025500F	500	20"	26.507,00
	HMASR0025600F	600	24"	37.124,00
	Ø 700-800 (28"-32")			-----
	Ø 900-1000-1200 (36"-40"-48")			-----

PN16	COD.	Ø		Euro
		mm	inch	
FILETTATO THREADED ROSCADO TARAUDE'	HMASR0016114M	32	1¼"	1.067,00
	HMASR0016112M	40	1½"	1.186,00
	HMASR001602M	50	2"	1.186,00

Pn25	COD.	Ø		Euro
		mm	inch	
FILETTATO THREADED ROSCADO TARAUDE'	HMASR0025114M	32	1¼"	1.067,00
	HMASR0025112M	40	1½"	1.186,00
	HMASR002502M	50	2"	1.186,00

/ Pressure Sustaining & Reducing  
/ Sostenedoras y Reductoras de Presión  
**Sostegno e Riduzione Pressione** / Mainteneur et Réducteur de Pression



HM-SP2M-RP2M

Standard Options  
1,0 ÷ 11,0 bar 2,0 ÷ 23,0 bar  
PN25  
2-way



1,0 ÷ 10,0 bar 2,0 ÷ 23,0 bar  
PN25  
2-way

PN16	COD.	Ø		Euro
		mm	inch	
FLANGED BRIDES	HMASPRP16050F	50	2"	1.548,00
	HMASPRP16065F	65	2½"	1.628,00
	HMASPRP16080F	80	3"	1.857,00
	HMASPRP16100F	100	4"	2.258,00
	HMASPRP16125F	125	5"	2.774,00
	HMASPRP16150F	150	6"	3.037,00
	HMASPRP16200F	200	8"	4.883,00
	HMASPRP16250F	250	10"	7.131,00
	HMASPRP16300F	300	12"	9.102,00
	HMASPRP16350F	350	14"	12.542,00
FLANGIATO BRIDADO	HMASPRP16400F	400	16"	16.381,00
	HMASPRP16500F	500	20"	24.176,00
	HMASPRP16600F	600	24"	33.830,00
	Ø 700-800 (28"-32")			-----
	Ø 900-1000-1200 (36"-40"-48")			-----

PN25	COD.	Ø		Euro
		mm	inch	
FLANGED BRIDES	HMASPRP25050F	50	2"	1.703,00
	HMASPRP25065F	65	2½"	1.791,00
	HMASPRP25080F	80	3"	2.043,00
	HMASPRP25100F	100	4"	2.484,00
	HMASPRP25125F	125	5"	3.051,00
	HMASPRP25150F	150	6"	3.341,00
	HMASPRP25200F	200	8"	5.371,00
	HMASPRP25250F	250	10"	7.844,00
	HMASPRP25300F	300	12"	10.012,00
	HMASPRP25350F	350	14"	13.796,00
FLANGIATO BRIDADO	HMASPRP25400F	400	16"	18.019,00
	HMASPRP25500F	500	20"	26.594,00
	HMASPRP25600F	600	24"	37.213,00
	Ø 700-800 (28"-32")			-----
	Ø 900-1000-1200 (36"-40"-48")			-----

PN16	COD.	Ø		Euro
		mm	inch	
FILETTATO THREADED ROSCADO TARAUDE'	HMASPRP16114M	32	1¼"	1.254,00
	HMASPRP16112M	40	1½"	1.393,00
	HMASPRP1602M	50	2"	1.393,00

Pn25	COD.	Ø		Euro
		mm	inch	
FILETTATO THREADED ROSCADO TARAUDE'	HMASPRP25114M	32	1¼"	1.254,00
	HMASPRP25112M	40	1½"	1.393,00
	HMASPRP2502M	50	2"	1.393,00

Funzioni Aggiuntive / Additional Functions / Funciones Adicionales / Fonctions Supplémentaires



HM-SPRP + EL2 Solenoide 2 vie / 2-way solenoid / Solenoide de 2 vías / Solenoide 2 voies (24V AC PN16)

Euro 119,00

ООО «ТИ-СИСТЕМС» ИНЖИНИРИНГ И ПОСТАВКА ТЕХНОЛОГИЧЕСКОГО ОБОРУДОВАНИЯ

Интернет: www.tisys.ru www.tisys.kz www.tisys.by www.tisys.by www.tisys.by

PN16	COD.	Ø		Euro
		mm	inch	
FLANGED BRIDES	HMAQP2M16050F	50	2"	1.593,00
	HMAQP2M16065F	65	2½"	1.674,00
	HMAQP2M16080F	80	3"	1.903,00
	HMAQP2M16100F	100	4"	2.303,00
	HMAQP2M16125F	125	5"	2.820,00
	HMAQP2M16150F	150	6"	3.084,00
	HMAQP2M16200F	200	8"	4.986,00
	HMAQP2M16250F	250	10"	7.233,00
	HMAQP2M16300F	300	12"	9.676,00
	HMAQP2M16350F	350	14"	13.144,00
FLANGIATO BRIDADO	HMAQP2M16400F	400	16"	17.242,00
	HMAQP2M16500F	500	20"	25.037,00
	HMAQP2M16600F	600	24"	34.690,00
	Ø 700-800 (28"-32")			-----
	Ø 900-1000-1200 (36"-40"-48")			-----

PN25	COD.	Ø		Euro
		mm	inch	
FLANGED BRIDES	HMAQP2M25050F	50	2"	1.752,00
	HMAQP2M25065F	65	2½"	1.841,00
	HMAQP2M25080F	80	3"	2.093,00
	HMAQP2M25100F	100	4"	2.533,00
	HMAQP2M25125F	125	5"	3.102,00
	HMAQP2M25150F	150	6"	3.392,00
	HMAQP2M25200F	200	8"	5.485,00
	HMAQP2M25250F	250	10"	7.956,00
	HMAQP2M25300F	300	12"	10.634,00
	HMAQP2M25350F	350	14"	14.425,00
FLANGIATO BRIDADO	HMAQP2M25400F	400	16"	18.966,00
	HMAQP2M25500F	500	20"	27.541,00
	HMAQP2M25600F	600	24"	38.159,00
	Ø 700-800 (28"-32")			-----
	Ø 900-1000-1200 (36"-40"-48")			-----



HM-QP2M

Standard    Optionals



PN16

PN16	COD.	Ø		Euro
		mm	inch	
FILETTATO THREADED ROSCADO TARAUDÉ'	HMAQP2M16114M32	1 1/4"		1.291,00
	HMAQP2M16112M40	1 1/2"		1.434,00
	HMAQP2M1602*M	50	2"	1.434,00

Pn25	COD.	Ø		Euro
		mm	inch	
FILETTATO THREADED ROSCADO TARAUDÉ'	HMAQP2M25114M32	1 1/4"		1.291,00
	HMAQP2M25112M40	1 1/2"		1.434,00
	HMAQP2M2502*M	50	2"	1.434,00

**Funzioni Aggiuntive / Additional Functions / Funciones Adicionales / Fonctions Supplémentaires**



HM-QP2M + RP2M    Pilota riduttore / Pressure reducing pilot / Piloto reductor / Pilote réducteur

Euro 156,00

**Sovravelocità / Excess Flow / Sobravelocidad / Survitesse**

PN16	COD.	Ø		Euro
		mm	inch	
FLANGED BRIDES	HMASV0016050F	50	2"	1.835,00
	HMASV0016065F	65	2½"	1.915,00
	HMASV0016080F	80	3"	2.144,00
	HMASV0016100F	100	4"	2.545,00
	HMASV0016125F	125	5"	3.060,00
	HMASV0016150F	150	6"	3.324,00
	HMASV0016200F	200	8"	5.274,00
	HMASV0016250F	250	10"	7.521,00
	HMASV0016300F	300	12"	10.236,00
	HMASV0016350F	350	14"	13.676,00
FLANGIATO BRIDADO	HMASV0016400F	400	16"	17.999,00
	HMASV0016500F	500	20"	25.794,00
	HMASV0016600F	600	24"	35.446,00
	Ø 700-800 (28"-32")			-----
	Ø 900-1000-1200 (36"-40"-48")			-----

PN25	COD.	Ø		Euro
		mm	inch	
FLANGED BRIDES	HMASV0025050F	50	2"	2.019,00
	HMASV0025065F	65	2½"	2.107,00
	HMASV0025080F	80	3"	2.358,00
	HMASV0025100F	100	4"	2.800,00
	HMASV0025125F	125	5"	3.366,00
	HMASV0025150F	150	6"	3.656,00
	HMASV0025200F	200	8"	5.801,00
	HMASV0025250F	250	10"	8.273,00
	HMASV0025300F	300	12"	11.260,00
	HMASV0025350F	350	14"	15.044,00
FLANGIATO BRIDADO	HMASV0025400F	400	16"	19.799,00
	HMASV0025500F	500	20"	28.373,00
	HMASV0025600F	600	24"	38.991,00
	Ø 700-800 (28"-32")			-----
	Ø 900-1000-1200 (36"-40"-48")			-----



HM-SV

Standard    Optionals



PN16

PN16	COD.	Ø		Euro
		mm	inch	
FILETTATO THREADED ROSCADO TARAUDÉ'	HMASV0016114M	32	1 1/4"	1.487,00
	HMASV0016112M	40	1 1/2"	1.652,00
	HMASV001602*M	50	2"	1.652,00

Pn25	COD.	Ø		Euro
		mm	inch	
FILETTATO THREADED ROSCADO TARAUDÉ'	HMASV0025114M	32	1 1/4"	1.487,00
	HMASV0025112M	40	1 1/2"	1.652,00
	HMASV002502*M	50	2"	1.652,00



**HM-EL**

Standard	Optionals
24V AC	24-110-220V
50÷60 Hz	N.C.
N.A. PN16	PN25



PN16	COD.	Ø		Euro
		mm	inch	
FLANGED BRIDES	HMAEL0016050F	50	2"	1.193,00
	HMAEL0016065F	65	2½"	1.272,00
	HMAEL0016080F	80	3"	1.501,00
	HMAEL0016100F	100	4"	1.903,00
	HMAEL0016125F	125	5"	2.418,00
	HMAEL0016150F	150	6"	2.683,00
	HMAEL0016200F	200	8"	4.517,00
	HMAEL0016250F	250	10"	6.764,00
	HMAEL0016300F	300	12"	8.644,00
	HMAEL0016350F	350	14"	12.083,00
	HMAEL0016400F	400	16"	15.935,00
	HMAEL0016500F	500	20"	23.730,00
FLANGIATO BRIDADO	HMAEL0016600F	600	24"	33.383,00
	Ø 700-800 (28"-32")			-----
	Ø 900-1000-1200 (36"-40"-48")			-----



PN25	COD.	Ø		Euro
		mm	inch	
FLANGED BRIDES	HMAEL0025050F	50	2"	1.312,00
	HMAEL0025065F	65	2½"	1.399,00
	HMAEL0025080F	80	3"	1.651,00
	HMAEL0025100F	100	4"	2.093,00
	HMAEL0025125F	125	5"	2.660,00
	HMAEL0025150F	150	6"	2.951,00
	HMAEL0025200F	200	8"	4.969,00
	HMAEL0025250F	250	10"	7.440,00
	HMAEL0025300F	300	12"	9.508,00
	HMAEL0025350F	350	14"	13.291,00
	HMAEL0025400F	400	16"	17.529,00
	HMAEL0025500F	500	20"	26.103,00
FLANGIATO BRIDADO	HMAEL0025600F	600	24"	36.721,00
	Ø 700-800 (28"-32")			-----
	Ø 900-1000-1200 (36"-40"-48")			-----



PN16	COD.	Ø		Euro
		mm	inch	
FILETTATO THREADED ROSCADO TARAUDE'	HMAEL0016114M	32	1¼"	967,00
	HMAEL0016112M	40	1½"	1.074,00
	HMAEL001602"M	50	2"	1.074,00



PN16	COD.	Ø		Euro
		mm	inch	
FILETTATO THREADED ROSCADO TARAUDE'	HMAEL0025114M	32	1¼"	967,00
	HMAEL0025112M	40	1½"	1.074,00
	HMAEL002502"M	50	2"	1.074,00



Funzioni Aggiuntive / Additional Functions / Funciones Adicionales / Fonctions Supplémentaires

HM-EL + NR Non Ritorno / No Return / Anti Retorno / Non Retour

Euro 99,00

Passo-passo / Step by Step / Paso-Paso / Pas-à-Pas



**HM-SS**

Standard	Optionals
24V AC	24-110-220V
50÷60 Hz	N.C.
N.A. PN16	PN25



PN16	COD.	Ø		Euro
		mm	inch	
FLANGED BRIDES	HMASS0016050F	50	2"	1.409,00
	HMASS0016065F	65	2½"	1.490,00
	HMASS0016080F	80	3"	1.719,00
	HMASS0016100F	100	4"	2.120,00
	HMASS0016125F	125	5"	2.636,00
	HMASS0016150F	150	6"	2.900,00
	HMASS0016200F	200	8"	4.734,00
	HMASS0016250F	250	10"	6.981,00
	HMASS0016300F	300	12"	8.861,00
	HMASS0016350F	350	14"	12.300,00
	HMASS0016400F	400	16"	16.164,00
	HMASS0016500F	500	20"	23.959,00
FLANGIATO BRIDADO	HMASS0016600F	600	24"	33.613,00
	Ø 700-800 (28"-32")			-----
	Ø 900-1000-1200 (36"-40"-48")			-----



PN25	COD.	Ø		Euro
		mm	inch	
FLANGED BRIDES	HMASS0025050F	50	2"	1.550,00
	HMASS0025065F	65	2½"	1.639,00
	HMASS0025080F	80	3"	1.891,00
	HMASS0025100F	100	4"	2.332,00
	HMASS0025125F	125	5"	2.900,00
	HMASS0025150F	150	6"	3.190,00
	HMASS0025200F	200	8"	5.207,00
	HMASS0025250F	250	10"	7.679,00
	HMASS0025300F	300	12"	9.747,00
	HMASS0025350F	350	14"	13.530,00
	HMASS0025400F	400	16"	17.780,00
	HMASS0025500F	500	20"	26.355,00
FLANGIATO BRIDADO	HMASS0025600F	600	24"	37.974,00
	Ø 700-800 (28"-32")			-----
	Ø 900-1000-1200 (36"-40"-48")			-----



PN16	COD.	Ø		Euro
		mm	inch	
FILETTATO THREADED ROSCADO TARAUDE'	HMASS0016114M	32	1¼"	1.141,00
	HMASS0016112M	40	1½"	1.268,00
	HMASS001602"M	50	2"	1.268,00



PN25	COD.	Ø		Euro
		mm	inch	
FILETTATO THREADED ROSCADO TARAUDE'	HMASS0025114M	32	1¼"	1.141,00
	HMASS0025112M	40	1½"	1.268,00
	HMASS002502"M	50	2"	1.268,00





PN16	COD.	Ø		Euro
		mm	inch	
FLANGED BRIDES	HMACP0016050F	50	2"	2.006,00
	HMACP0016065F	65	2½"	2.086,00
	HMACP0016080F	80	3"	2.316,00
	HMACP0016100F	100	4"	2.717,00
	HMACP0016125F	125	5"	3.233,00
	HMACP0016150F	150	6"	3.496,00
	HMACP0016200F	200	8"	5.388,00
	HMACP0016250F	250	10"	7.635,00
	HMACP0016300F	300	12"	9.572,00
	HMACP0016350F	350	14"	13.012,00
FLANGIATO BRIDADO	HMACP0016400F	400	16"	16.990,00
	HMACP0016500F	500	20"	24.785,00
	HMACP0016600F	600	24"	34.437,00
	Ø 700-800 (28"-32")			-----
	Ø 900-1000-1200 (36"-40"-48")			-----

PN25	COD.	Ø		Euro
		mm	inch	
FLANGED BRIDES	HMACP0025050F	50	2"	2.207,00
	HMACP0025065F	65	2½"	2.295,00
	HMACP0025080F	80	3"	2.548,00
	HMACP0025100F	100	4"	2.989,00
	HMACP0025125F	125	5"	3.556,00
	HMACP0025150F	150	6"	3.846,00
	HMACP0025200F	200	8"	5.927,00
	HMACP0025250F	250	10"	8.399,00
	HMACP0025300F	300	12"	10.529,00
	HMACP0025350F	350	14"	14.313,00
FLANGIATO BRIDADO	HMACP0025400F	400	16"	18.689,00
	HMACP0025500F	500	20"	27.264,00
	HMACP0025600F	600	24"	37.881,00
	Ø 700-800 (28"-32")			-----
	Ø 900-1000-1200 (36"-40"-48")			-----



HM-CP

Standard      Optionals

24V AC            24-110-220V  
50÷60 Hz        50÷60 Hz  
N.C. PN16        N.O.



220V AC            24-110-220V  
50÷60 Hz        50÷60 Hz  
N.C.                N.O.

PN16	COD.	Ø		Euro
		mm	inch	
FILETTATO THREADED ROSCADO TARAUDÉ	HMACP0016114M	32	1¼"	1.625,00
	HMACP0016112M	40	1½"	1.805,00
	HMACP001602M	50	2"	1.805,00

Pn25	COD.	Ø		Euro
		mm	inch	
FILETTATO THREADED ROSCADO TARAUDÉ	HMACP0025114M	32	1¼"	1.625,00
	HMACP0025112M	40	1½"	1.805,00
	HMACP002502M	50	2"	1.805,00

/ Pressure Reducing 2 Levels / Reductoras De Presion 2 Niveles  
Riduzione Pressione due livelli / Réduction de Pression 2 Niveaux

PN16	COD.	Ø		Euro
		mm	inch	
FLANGED BRIDES	HMARP2L16050F	50	2"	1.699,00
	HMARP2L16065F	65	2½"	1.780,00
	HMARP2L16080F	80	3"	2.099,00
	HMARP2L16100F	100	4"	2.409,00
	HMARP2L16125F	125	5"	2.926,00
	HMARP2L16150F	150	6"	3.190,00
	HMARP2L16200F	200	8"	5.023,00
	HMARP2L16250F	250	10"	7.271,00
	HMARP2L16300F	300	12"	9.151,00
	HMARP2L16350F	350	14"	12.590,00
FLANGIATO BRIDADO	HMARP2L16400F	400	16"	16.453,00
	HMARP2L16500F	500	20"	24.250,00
	HMARP2L16600F	600	24"	33.902,00
	Ø 700-800 (28"-32")			-----
	Ø 900-1000-1200 (36"-40"-48")			-----

PN25	COD.	Ø		Euro
		mm	inch	
FLANGED BRIDES	HMARP2L25050F	50	2"	1.869,00
	HMARP2L25065F	65	2½"	1.958,00
	HMARP2L25080F	80	3"	2.210,00
	HMARP2L25100F	100	4"	2.650,00
	HMARP2L25125F	125	5"	3.219,00
	HMARP2L25150F	150	6"	3.509,00
	HMARP2L25200F	200	8"	5.525,00
	HMARP2L25250F	250	10"	7.998,00
	HMARP2L25300F	300	12"	10.066,00
	HMARP2L25350F	350	14"	13.849,00
FLANGIATO BRIDADO	HMARP2L25400F	400	16"	18.098,00
	HMARP2L25500F	500	20"	26.675,00
	HMARP2L25600F	600	24"	36.292,00
	Ø 700-800 (28"-32")			-----
	Ø 900-1000-1200 (36"-40"-48")			-----



HM-RP-2L

Standard      Optionals

1,0÷11,0 bar      2,0÷23,0 bar  
PN25  
2-way



PN16	COD.	Ø		Euro
		mm	inch	
FILETTATO THREADED ROSCADO TARAUDÉ	HMARP2L16114M	32	1¼"	1.376,00
	HMARP2L16112M	40	1½"	1.529,00
	HMARP2L1602M	50	2"	1.529,00

Pn25	COD.	Ø		Euro
		mm	inch	
FILETTATO THREADED ROSCADO TARAUDÉ	HMARP2L25114M	32	1¼"	1.376,00
	HMARP2L25112M	40	1½"	1.529,00
	HMARP2L2502M	50	2"	1.529,00



### HM-GAL

Standard    Optionals

PN16            INOX  
PP



PN16	COD.	Ø		Euro
		mm	inch	
FLANGED BRIDES	HMAGAL016050F	50	2"	1.078,00
	HMAGAL016065F	65	2½"	1.158,00
	HMAGAL016080F	80	3"	1.388,00
	HMAGAL016100F	100	4"	1.788,00
	HMAGAL016125F	125	5"	2.304,00
	HMAGAL016150F	150	6"	2.568,00
	HMAGAL016200F	200	8"	4.654,00
	HMAGAL016250F	250	10"	6.902,00
	HMAGAL016300F	300	12"	9.286,00
	HMAGAL016350F	350	14"	12.725,00
FLANGIATO BRIDADO	HMAGAL016400F	400	16"	16.508,00
	HMAGAL016500F	500	20"	24.304,00
	HMAGAL016600F	600	24"	33.956,00
	Ø 700-800 (28"-32")			-----
	Ø 900-1000-1200 (36"-40"-48")			-----

PN25	COD.	Ø		Euro
		mm	inch	
FLANGED BRIDES	HMAGAL025050F	50	2"	1.186,00
	HMAGAL025065F	65	2½"	1.274,00
	HMAGAL025080F	80	3"	1.527,00
	HMAGAL025100F	100	4"	1.967,00
	HMAGAL025125F	125	5"	2.534,00
	HMAGAL025150F	150	6"	2.825,00
	HMAGAL025200F	200	8"	5.119,00
	HMAGAL025250F	250	10"	7.592,00
	HMAGAL025300F	300	12"	10.215,00
	HMAGAL025350F	350	14"	13.998,00
FLANGIATO BRIDADO	HMAGAL025400F	400	16"	18.159,00
	HMAGAL025500F	500	20"	26.734,00
	HMAGAL025600F	600	24"	37.352,00
	Ø 700-800 (28"-32")			-----
	Ø 900-1000-1200 (36"-40"-48")			-----

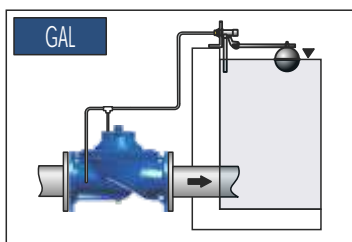

PN16	COD.	Ø		Euro
		mm	inch	
FILETTATO THREADED ROSCADO TARAUDE'	HMAGAL016114M	32	1¼"	873,00
	HMAGAL016112M	40	1½"	970,00
	HMAGAL01602*M	50	2"	970,00

Pn25	COD.	Ø		Euro
		mm	inch	
FILETTATO THREADED ROSCADO TARAUDE'	HMAGAL025114M	32	1¼"	873,00
	HMAGAL025112M	40	1½"	970,00
	HMAGAL02502*M	50	2"	970,00

#### Funzioni Aggiuntive / Additional Functions / Funciones Adicionales / Fonctions Supplémentaires



HM-GAL + EL2 Solenoide 2 vie / 2-way solenoid / Solenoide de 2 vias / Solenoide 2 voies (24V AC PN16)

Euro 119,00

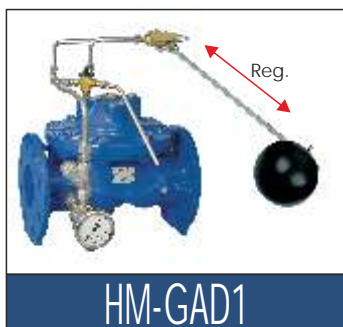

### HM-GAD1

Standard    Optionals

0,5 mt  
PN16  
PP



PN16	COD.	Ø		Euro
		mm	inch	
FLANGED BRIDES	HMAGAD116050F	50	2"	1.377,00
	HMAGAD116065F	65	2½"	1.455,00
	HMAGAD116080F	80	3"	1.684,00
	HMAGAD116100F	100	4"	2.086,00
	HMAGAD116125F	125	5"	2.601,00
	HMAGAD116150F	150	6"	2.866,00
	HMAGAD116200F	200	8"	4.952,00
	HMAGAD116250F	250	10"	7.200,00
	HMAGAD116300F	300	12"	9.126,00
	HMAGAD116350F	350	14"	12.564,00
FLANGIATO BRIDADO	HMAGAD116400F	400	16"	16.806,00
	HMAGAD116500F	500	20"	24.602,00
	HMAGAD116600F	600	24"	34.254,00
	Ø 700-800 (28"-32")			-----
	Ø 900-1000-1200 (36"-40"-48")			-----

PN25	COD.	Ø		Euro
		mm	inch	
FLANGED BRIDES	HMAGAD125050F	50	2"	1.515,00
	HMAGAD125065F	65	2½"	1.601,00
	HMAGAD125080F	80	3"	1.852,00
	HMAGAD125100F	100	4"	2.295,00
	HMAGAD125125F	125	5"	2.861,00
	HMAGAD125150F	150	6"	3.153,00
	HMAGAD125200F	200	8"	5.447,00
	HMAGAD125250F	250	10"	7.920,00
	HMAGAD125300F	300	12"	10.039,00
	HMAGAD125350F	350	14"	13.820,00
FLANGIATO BRIDADO	HMAGAD125400F	400	16"	18.487,00
	HMAGAD125500F	500	20"	27.062,00
	HMAGAD125600F	600	24"	37.679,00
	Ø 700-800 (28"-32")			-----
	Ø 900-1000-1200 (36"-40"-48")			-----

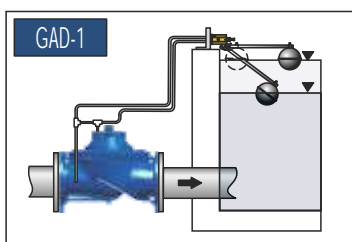

PN16	COD.	Ø		Euro
		mm	inch	
FILETTATO THREADED ROSCADO TARAUDE'	HMAGAD116114M	32	1¼"	1.115,00
	HMAGAD116112M	40	1½"	1.239,00
	HMAGAD11602*M	50	2"	1.239,00

Pn25	COD.	Ø		Euro
		mm	inch	
FILETTATO THREADED ROSCADO TARAUDE'	HMAGAD125114M	32	1¼"	1.115,00
	HMAGAD125112M	40	1½"	1.239,00
	HMAGAD12502*M	50	2"	1.239,00

PN16	COD.	Ø		Euro	
		mm	inch		
FLANGED BRIDES	HMAGAD216050F	50	2"	1.524,00	
	HMAGAD216065F	65	2½"	1.605,00	
	HMAGAD216080F	80	3"	1.834,00	
	HMAGAD216100F	100	4"	2.234,00	
	HMAGAD216125F	125	5"	2.752,00	
	HMAGAD216150F	150	6"	3.015,00	
	HMAGAD216200F	200	8"	5.101,00	
	HMAGAD216250F	250	10"	7.348,00	
	HMAGAD216300F	300	12"	9.274,00	
	HMAGAD216350F	350	14"	12.713,00	
	HMAGAD216400F	400	16"	16.954,00	
	HMAGAD216500F	500	20"	24.750,00	
	HMAGAD216600F	600	24"	34.392,00	
	Ø 700-800 (28"-32")		-----		
	Ø 900-1000-1200 (36"-40"-48")		-----		
FLANGIATO BRIDADO					

PN25	COD.	Ø		Euro	
		mm	inch		
FLANGED BRIDES	HMAGAD225050F	50	2"	1.676,00	
	HMAGAD225065F	65	2½"	1.766,00	
	HMAGAD225080F	80	3"	2.017,00	
	HMAGAD225100F	100	4"	2.457,00	
	HMAGAD225125F	125	5"	3.027,00	
	HMAGAD225150F	150	6"	3.317,00	
	HMAGAD225200F	200	8"	5.611,00	
	HMAGAD225250F	250	10"	8.083,00	
	HMAGAD225300F	300	12"	10.201,00	
	HMAGAD225350F	350	14"	13.984,00	
	HMAGAD225400F	400	16"	18.649,00	
	HMAGAD225500F	500	20"	27.225,00	
	HMAGAD225600F	600	24"	37.831,00	
	Ø 700-800 (28"-32")		-----		
	Ø 900-1000-1200 (36"-40"-48")		-----		
FLANGIATO BRIDADO					

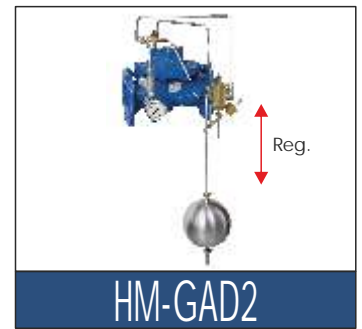

HM-GAD2

	Standard	Optionals
	1,2 mt	1,5 mt
	PN16	2,0 mt
	INOX	2,5 mt

PN16	COD.	Ø		Euro
		mm	inch	
FILETTATO THREADED ROSCADO TARAUDÉ	HMAGAD216114M32	32	1¼"	1.235,00
	HMAGAD216112M40	40	1½"	1.372,00
	HMAGAD21602M50	50	2"	1.372,00

PN25	COD.	Ø		Euro
		mm	inch	
FILETTATO THREADED ROSCADO TARAUDÉ	HMAGAD225114M32	32	1¼"	1.235,00
	HMAGAD225112M40	40	1½"	1.372,00
	HMAGAD22502M50	50	2"	1.372,00

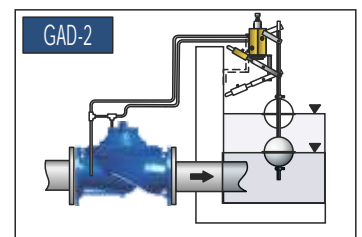

GAD-2

Controllo Altimetrico / Altimetric Control / Control Altimetrico / Contrôle Altimétrique

PN16	COD.	Ø		Euro	
		mm	inch		
FLANGED BRIDES	HMAALTO16050F	50	2"	1.777,00	
	HMAALTO16065F	65	2½"	1.857,00	
	HMAALTO16080F	80	3"	2.086,00	
	HMAALTO16100F	100	4"	2.487,00	
	HMAALTO16125F	125	5"	3.004,00	
	HMAALTO16150F	150	6"	3.267,00	
	HMAALTO16200F	200	8"	5.319,00	
	HMAALTO16250F	250	10"	7.566,00	
	HMAALTO16300F	300	12"	9.939,00	
	HMAALTO16350F	350	14"	13.377,00	
	HMAALTO16400F	400	16"	17.161,00	
	HMAALTO16500F	500	20"	24.957,00	
	HMAALTO16600F	600	24"	34.609,00	
	Ø 700-800 (28"-32")		-----		
	Ø 900-1000-1200 (36"-40"-48")		-----		
FLANGIATO BRIDADO					

PN25	COD.	Ø		Euro	
		mm	inch		
FLANGED BRIDES	HMAALTO25050F	50	2"	1.955,00	
	HMAALTO25065F	65	2½"	2.043,00	
	HMAALTO25080F	80	3"	2.295,00	
	HMAALTO25100F	100	4"	2.736,00	
	HMAALTO25125F	125	5"	3.304,00	
	HMAALTO25150F	150	6"	3.594,00	
	HMAALTO25200F	200	8"	5.851,00	
	HMAALTO25250F	250	10"	8.323,00	
	HMAALTO25300F	300	12"	10.933,00	
	HMAALTO25350F	350	14"	14.715,00	
	HMAALTO25400F	400	16"	18.877,00	
	HMAALTO25500F	500	20"	27.453,00	
	HMAALTO25600F	600	24"	38.070,00	
	Ø 700-800 (28"-32")		-----		
	Ø 900-1000-1200 (36"-40"-48")		-----		
FLANGIATO BRIDADO					



HM-ALT

	Standard	Optionals
	PN16	8÷20 m.c.a.
	1÷10 m.c.a.	18÷30 m.c.a.

PN16	COD.	Ø		Euro
		mm	inch	
FILETTATO THREADED ROSCADO TARAUDÉ	HMAALTO16114M	32	1¼"	1.439,00
	HMAALTO16112M	40	1½"	1.599,00
	HMAALTO1602M	50	2"	1.599,00

PN25	COD.	Ø		Euro
		mm	inch	
FILETTATO THREADED ROSCADO TARAUDÉ	HMAALTO25114M	32	1¼"	1.439,00
	HMAALTO25112M	40	1½"	1.599,00
	HMAALTO2502M	50	2"	1.599,00

Funzioni Aggiuntive / Additional Functions / Funciones Adicionales / Fonctions Supplémentaires



HM-ALT + EL2 Solenoide 2 vie / 2-way solenoid / Solenoide de 2 vías / Solenoide 2 voies (24V AC PN16)

Euro 119,00

# Hydraulic Control Valves

PN 16/25/40

HM-D  
Double Chamber

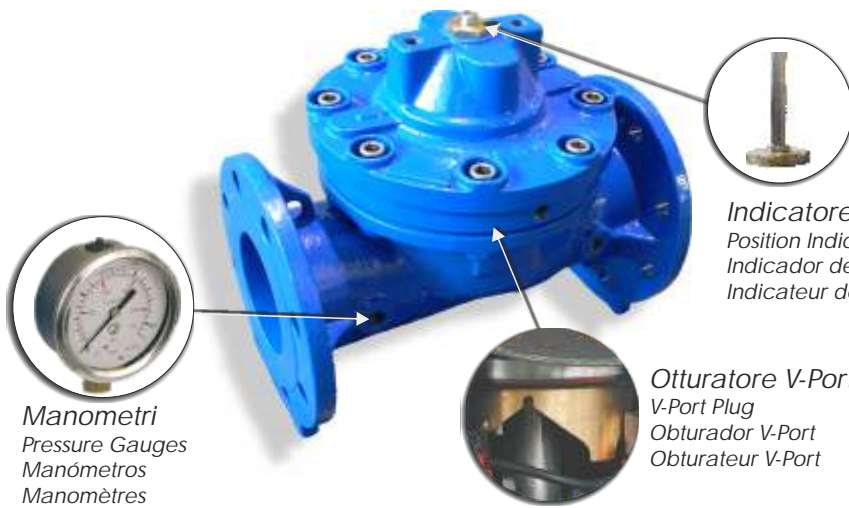

Manometri  
Pressure Gauges  
Manómetros  
Manomètres

Indicatore di Posizione  
Position Indicator  
Indicador de Posición  
Indicateur de Position

Otturatore V-Port  
V-Port Plug  
Obturator V-Port  
Obtuteur V-Port

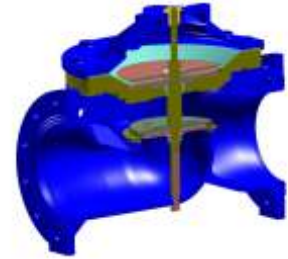

## Riduzione Pressione / Pressure Reducing / Reductoras de Presión / Réduction de Pression

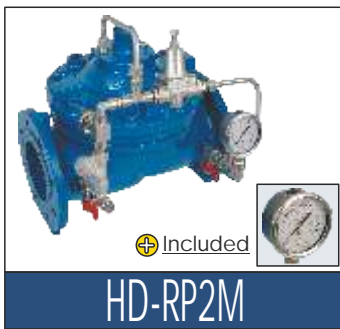

Included

HD-RP2M

Standard    Optionals



1,0÷11,0 bar  
PN25  
2-way

FLANGED BRIDES	COD.	Ø		Euro
		mm	inch	
FLANGIATO BRIDADO	HDARP2M16050F	50	2"	2.767,00
	HDARP2M16065F	65	2 1/2"	2.963,00
	HDARP2M16080F	80	3"	3.547,00
	HDARP2M16100F	100	4"	4.579,00
	HDARP2M16125F	125	5"	5.885,00
	HDARP2M16150F	150	6"	6.938,00
	HDARP2M16200F	200	8"	11.789,00
	HDARP2M16250F	250	10"	18.943,00
	Ø 300-1200 (12"-48")			-----

FLANGED BRIDES	COD.	Ø		Euro
		mm	inch	
FLANGIATO BRIDADO	HDARP2M25050F	50	2"	3.043,00
	HDARP2M25065F	65	2 1/2"	3.259,00
	HDARP2M25080F	80	3"	3.902,00
	HDARP2M25100F	100	4"	5.037,00
	HDARP2M25125F	125	5"	6.474,00
	HDARP2M25150F	150	6"	7.632,00
	HDARP2M25200F	200	8"	12.968,00
	HDARP2M25250F	250	10"	20.837,00
	Ø 300-1200 (12"-48")			-----

FILETTATO THREADED ROSCADO TARAUDE'	COD.	Ø		Euro
		mm	inch	
FLANGIATO BRIDADO	HDARP2M16114M	32	1 1/4"	2.465,00
	HDARP2M16112M	40	1 1/2"	2.739,00
	HDARP2M1602"M	50	2"	2.739,00

FILETTATO THREADED ROSCADO TARAUDE'	COD.	Ø		Euro
		mm	inch	
FLANGIATO BRIDADO	HDARP2M25114M	32	1 1/4"	2.465,00
	HDARP2M25112M	40	1 1/2"	2.739,00
	HDARP2M2502"M	50	2"	2.739,00



Funzioni Aggiuntive / Additional Functions / Funciones Adicionales / Fonctions Supplémentaires

HM-SPRP + EL2 Solenoide 2 vie / 2-way solenoid / Solenoide de 2 vias / Solenoide 2 voies (24V AC PN16)

Euro 119,00

## Sostegno Pressione / Pressure Sustaining / Sostenedora de Presión / Mainteneur de Pression



Included

HD-SP2M

Standard    Optionals



0,5÷7,0 bar    1,0÷13,0 bar  
PN25  
2-way

FLANGED BRIDES	COD.	Ø		Euro
		mm	inch	
FLANGIATO BRIDADO	HDASP2M16050F	50	2"	2.964,00
	HDASP2M16065F	65	2 1/2"	3.157,00
	HDASP2M16080F	80	3"	3.742,00
	HDASP2M16100F	100	4"	4.774,00
	HDASP2M16125F	125	5"	6.080,00
	HDASP2M16150F	150	6"	7.133,00
	HDASP2M16200F	200	8"	11.984,00
	HDASP2M16250F	250	10"	19.138,00
	Ø 300-1200 (12"-48")			-----

FLANGED BRIDES	COD.	Ø		Euro
		mm	inch	
FLANGIATO BRIDADO	HDASP2M25050F	50	2"	3.260,00
	HDASP2M25065F	65	2 1/2"	3.437,00
	HDASP2M25080F	80	3"	4.116,00
	HDASP2M25100F	100	4"	5.251,00
	HDASP2M25125F	125	5"	6.688,00
	HDASP2M25150F	150	6"	7.846,00
	HDASP2M25200F	200	8"	13.182,00
	HDASP2M25250F	250	10"	21.052,00
	Ø 300-1200 (12"-48")			-----

FILETTATO THREADED ROSCADO TARAUDE'	COD.	Ø		Euro
		mm	inch	
FLANGIATO BRIDADO	HDASP2M16114M	32	1 1/4"	2.401,00
	HDASP2M16112M	40	1 1/2"	2.668,00
	HDASP2M1602"M	50	2"	2.668,00

FILETTATO THREADED ROSCADO TARAUDE'	COD.	Ø		Euro
		mm	inch	
FLANGIATO BRIDADO	HDASP2M25114M	32	1 1/4"	2.401,00
	HDASP2M25112M	40	1 1/2"	2.668,00
	HDASP2M2502"M	50	2"	2.668,00



Funzioni Aggiuntive / Additional Functions / Funciones Adicionales / Fonctions Supplémentaires

HM-SPRP + EL2 Solenoide 2 vie / 2-way solenoid / Solenoide de 2 vias / Solenoide 2 voies (24V AC PN16)

Euro 119,00

PN16	COD.	Ø		Euro
		mm	inch	
FLANGED BRIDES	HDAQP2M16050F	50	2"	3.314,00
	HDAQP2M16065F	65	2½"	3.508,00
	HDAQP2M16080F	80	3"	4.093,00
	HDAQP2M16100F	100	4"	5.125,00
	HDAQP2M16125F	125	5"	6.431,00
	HDAQP2M16150F	150	6"	7.484,00
	HDAQP2M16200F	200	8"	12.452,00
	HDAQP2M16250F	250	10"	19.606,00
FLANGIATO BRIDADO	Ø 300-1200 (12"-48")			-----

PN25	COD.	Ø		Euro
		mm	inch	
FLANGED BRIDES	HDAQP2M25050F	50	2"	3.645,00
	HDAQP2M25065F	65	2½"	3.859,00
	HDAQP2M25080F	80	3"	4.502,00
	HDAQP2M25100F	100	4"	5.638,00
	HDAQP2M25125F	125	5"	7.074,00
	HDAQP2M25150F	150	6"	8.232,00
	HDAQP2M25200F	200	8"	13.697,00
	HDAQP2M25250F	250	10"	21.567,00
FLANGIATO BRIDADO	Ø 300-1200 (12"-48")			-----

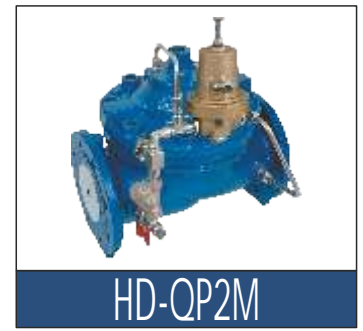

HD-QP2M

Standard Options



PN25  
2-way

PN16	COD.	Ø		Euro
		mm	inch	
FILETTATO THREADED ROSCADO TARAUDE'	HDAQP2M16114M	32	1¼"	2.685,00
	HDAQP2M16112M	40	1½"	2.983,00
	HDAQP2M1602"M	50	2"	2.983,00

PN25	COD.	Ø		Euro
		mm	inch	
FILETTATO THREADED ROSCADO TARAUDE'	HDAQP2M25114M	32	1¼"	2.685,00
	HDAQP2M25112M	40	1½"	2.983,00
	HDAQP2M2502"M	50	2"	2.983,00

Funzioni Aggiuntive / Additional Functions / Funciones Adicionales / Fonctions Supplémentaires



HM-QP2M + RP2M Pilota riduttore / Pressure reducing pilot / Piloto reductor  
Pilote réducteur (1,0÷11,0 bar)

Euro 156,00

Elettroidraulica / Electrohydraulic / Electrohidráulica / Electro-hydraulique

PN16	COD.	Ø		Euro
		mm	inch	
FLANGED BRIDES	HDAELO016050F	50	2"	2.630,00
	HDAELO016065F	65	2½"	2.825,00
	HDAELO016080F	80	3"	3.410,00
	HDAELO016100F	100	4"	4.444,00
	HDAELO016125F	125	5"	5.748,00
	HDAELO016150F	150	6"	6.801,00
	HDAELO016200F	200	8"	11.655,00
	HDAELO016250F	250	10"	18.805,00
FLANGIATO BRIDADO	Ø 300-1200 (12"-48")			-----

PN25	COD.	Ø		Euro
		mm	inch	
FLANGED BRIDES	HDAELO025050F	50	2"	2.893,00
	HDAELO025065F	65	2½"	3.108,00
	HDAELO025080F	80	3"	3.751,00
	HDAELO025100F	100	4"	4.888,00
	HDAELO025125F	125	5"	6.323,00
	HDAELO025150F	150	6"	7.481,00
	HDAELO025200F	200	8"	12.281,00
	HDAELO025250F	250	10"	20.686,00
FLANGIATO BRIDADO	Ø 300-1200 (12"-48")			-----

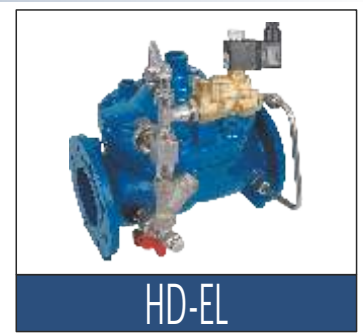

HD-EL

Standard Options



24V AC 24-110-220V  
50÷60 Hz N.C.  
N.A. PN16 PN25

PN16	COD.	Ø		Euro
		mm	inch	
FILETTATO THREADED ROSCADO TARAUDE'	HDAELO016114M	32	1¼"	2.130,00
	HDAELO016112M	40	1½"	2.367,00
	HDAELO01602"M	50	2"	2.367,00

PN25	COD.	Ø		Euro
		mm	inch	
FILETTATO THREADED ROSCADO TARAUDE'	HDAELO025114M	32	1¼"	2.130,00
	HDAELO025112M	40	1½"	2.367,00
	HDAELO02502"M	50	2"	2.367,00

Scarico Rapido / Quick Relief / Alivio Rápido / Décharge Rapide

PN16	COD.	Ø		Euro
		mm	inch	
FLANGED BRIDES	HDASR0016050F	50	2"	2.845,00
	HDASR0016065F	65	2½"	3.040,00
	HDASR0016080F	80	3"	3.625,00
	HDASR0016100F	100	4"	4.657,00
	HDASR0016125F	125	5"	5.964,00
	HDASR0016150F	150	6"	7.016,00
	HDASR0016200F	200	8"	11.927,00
	HDASR0016250F	250	10"	19.079,00
FLANGIATO BRIDADO	Ø 300-1200 (12"-48")			-----

PN25	COD.	Ø		Euro
		mm	inch	
FLANGED BRIDES	HDASR0025050F	50	2"	3.130,00
	HDASR0025065F	65	2½"	3.222,00
	HDASR0025080F	80	3"	3.988,00
	HDASR0025100F	100	4"	5.123,00
	HDASR0025125F	125	5"	6.560,00
	HDASR0025150F	150	6"	7.718,00
	HDASR0025200F	200	8"	13.120,00
	HDASR0025250F	250	10"	20.987,00
FLANGIATO BRIDADO	Ø 300-1200 (12"-48")			-----



HD-SR

Standard Options



1,0÷10,0 bar 1,5÷22,0 bar  
PN25

PN16	COD.	Ø		Euro
		mm	inch	
FILETTATO THREADED ROSCADO TARAUDE'	HDASR0016114M	32	1¼"	2.305,00
	HDASR0016112M	40	1½"	2.561,00
	HDASR001602"M	50	2"	2.561,00

PN25	COD.	Ø		Euro
		mm	inch	
FILETTATO THREADED ROSCADO TARAUDE'	HDASR0025114M	32	1¼"	2.305,00
	HDASR0025112M	40	1½"	2.561,00
	HDASR002502"M	50	2"	2.561,00

# Hydraulic Control Valves

PN 16/25/40

HM-P  
Piston  
(Proportional)

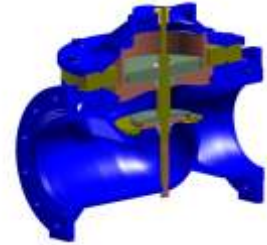

Manometri  
Pressure Gauges  
Manómetros  
Manomètres

Indicatore di Posizione  
Position Indicator  
Indicador de Posición  
Indicateur de Position

Otturatore V-Port  
V-Port Plug  
Obturador V-Port  
Obtuteur V-Port

## Riduzione Pressione Proporzionale / Proportional Pressure Reducing / Reductora Proporcional / Réduction Proportionnelle



**Standard**    **Optionals**  
Pin/Pout      Pin/Pout  
3÷1            2÷1  
                  4÷1

PN16	COD.	Ø		Euro	
		mm	inch		
FLANGIATO BRIDADO	HPARPO316050F	50	2"	3.328,00	
	HPARPO316065F	65	2½"	3.675,00	
	HPARPO316080F	80	3"	4.634,00	
	HPARPO316100F	100	4"	6.309,00	
	HPARPO316125F	125	5"	8.473,00	
	HPARPO316150F	150	6"	9.963,00	
	HPARPO316200F	200	8"	17.497,00	
	HPARPO316250F	250	10"	28.400,00	
	Ø 300-1200 (12"-48")				-----

PN25	COD.	Ø		Euro	
		mm	inch		
FLANGIATO BRIDADO	HPARPO325050F	50	2"	3.661,00	
	HPARPO325065F	65	2½"	4.043,00	
	HPARPO325080F	80	3"	5.097,00	
	HPARPO325100F	100	4"	6.940,00	
	HPARPO325125F	125	5"	9.320,00	
	HPARPO325150F	150	6"	10.959,00	
	HPARPO325200F	200	8"	19.247,00	
	HPARPO325250F	250	10"	31.240,00	
	Ø 300-1200 (12"-48")				-----

PN16	COD.	Ø		Euro
		mm	inch	
FILETTATO THREADED ROSCADO TARAUDÉ	HPARPO316114M	32	1¼"	2.696,00
	HPARPO316112M	40	1½"	2.995,00
	HPARPO31602*M	50	2"	2.995,00

PN25	COD.	Ø		Euro
		mm	inch	
FILETTATO THREADED ROSCADO TARAUDÉ	HPARPO325114M	32	1¼"	2.696,00
	HPARPO325112M	40	1½"	2.995,00
	HPARPO32502*M	50	2"	2.995,00

## Riduttrice Proporzionale Elettrica / Réduction Proportionnelle et Eléctrique



**Standard**    **Optionals**  
24V AC        24-110-220V  
50÷60 Hz    N.C.  
N.A. PN16    PN25

PN16	COD.	Ø		Euro	
		mm	inch		
FLANGIATO BRIDADO	HPARPE316050F	50	2"	3.532,00	
	HPARPE316065F	65	2½"	3.880,00	
	HPARPE316080F	80	3"	4.839,00	
	HPARPE316100F	100	4"	6.513,00	
	HPARPE316125F	125	5"	8.677,00	
	HPARPE316150F	150	6"	10.168,00	
	HPARPE316200F	200	8"	17.701,00	
	HPARPE316250F	250	10"	28.604,00	
	Ø 300-1200 (12"-48")				-----

PN25	COD.	Ø		Euro	
		mm	inch		
FLANGIATO BRIDADO	HPARPE325050F	50	2"	3.885,00	
	HPARPE325065F	65	2½"	4.268,00	
	HPARPE325080F	80	3"	5.323,00	
	HPARPE325100F	100	4"	7.164,00	
	HPARPE325125F	125	5"	9.545,00	
	HPARPE325150F	150	6"	11.185,00	
	HPARPE325200F	200	8"	19.471,00	
	HPARPE325250F	250	10"	31.464,00	
	Ø 300-1200 (12"-48")				-----

PN16	COD.	Ø		Euro
		mm	inch	
FILETTATO THREADED ROSCADO TARAUDÉ	HPARPE316114M	32	1¼"	2.860,00
	HPARPE316112M	40	1½"	3.178,00
	HPARPE31602*M	50	2"	3.178,00

PN25	COD.	Ø		Euro
		mm	inch	
FILETTATO THREADED ROSCADO TARAUDÉ	HPARPE325114M	32	1¼"	2.860,00
	HPARPE325112M	40	1½"	3.178,00
	HPARPE32502*M	50	2"	3.178,00

Parti di ricambio / Refill parts / Piezas de repuestos / Pièces de réchange

Mod.	Tipo / Type / Tipo / Type		COD.	Euro
RHM -KIT	Kit guarnizioni / Joints kit	DN1*1/4-65	RHMKIT114-65	51,00
	Juego de juntas / Kit des joints	DN80-100-125	RHMKIT080-125	104,00
		DN150	RHMKIT000-150	170,00
		DN200-250	RHMKIT200-250	247,00
		DN300-350	RHMKIT300-350	750,00
		Dn400 ÷ DN1200	-----	
RHD -KIT	Kit guarnizioni / Joints kit	DN1*1/4-65	RHDKIT114-65	89,00
	Juego de juntas / Kit des joints	DN80-100-125	RHDKIT080-125	179,00
		DN150	RHDKIT000-150	239,00
		DN200-250	RHDKIT200-250	313,00
		DN300	RHDKIT000-300	-----
RHP -KIT	Kit guarnizioni / Joints kit	DN1*1/4-65	RHPKIT114-65	-----
	Juego de juntas / Kit des joints	DN80-100-125	RHPKIT080-125	-----
		DN150	RHPKIT000-150	-----
		DN200-250	RHPKIT200-250	-----
		DN300	RHPKIT000-300	-----



RHM-KIT



RHD-KIT



RHP-KIT

Single Chamber  
HM



Double Chamb  
HM-D

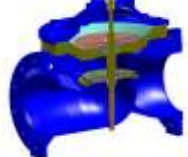

Proportional  
HM-P

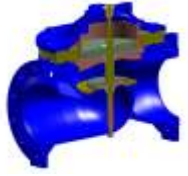

Accessori / Accessories / Accesorios / Accessoires

Mod.	Tipo / Type / Tipo / Type		Inch		COD.	Euro
VPO	Otturatore V-Port / V-port plug	DN1*1/4-65	1*1/4-2*1/2		RHMVPO114-065	75,00
	Obturador V-port / Obturateur V-port	DN80-100-125	3"-4"-5"		RHMVPO080-125	120,00
		DN150	6"		RHMVPO000-150	264,00
		DN200-250	8"-10"		RHMVPO200-250	427,00
		DN300-350	12"-14"		RHMVPO300-350	1.048,00
			Dn400 ÷ DN1200	16" ÷ 48"		-----
ESS	Estensione stelo / Stem extension	DN1*1/4-65	1*1/4-2*1/2		RHMIPV114-065	71,00
	Prolongación del eje / Extension de l'ax	DN80-100-125	3"-4"-5"		RHMIPV080-125	87,00
		DN150	6"		RHMIPV000-150	103,00
		DN200-250	8"-10"		RHMIPV200-250	120,00
		DN300-350	12"-14"		RHMIPV300-350	-----
			Dn400 ÷ DN1200	16" ÷ 48"		-----
MAN	Manometro / Pressure gauge / Manómetro / Manomètre		1/4"	M	RRAMAX4R06316	29,00
			1/2"	M	RRAMAX2R10016	83,00
FILY	Filtro a "Y" / "Y" strainer / Filtro de "Y" / Filtre à "Y"		1/4"	F-F	RRAFILYX1/4"M	92,00
VS2	Valvola a sfera / Ball valve / Válvula de esfera / Vanne à sphère		1/4"	M-F	RRASV2VX1/4MF	21,00
			1/2"	M-F	RRASV2VX1/2MF	53,00
SPO	Valvola a spillo / Needle valve / Válvula de aguja / Robinet pointeau		1/4"	F-F	RRASPX1/4"FF	78,00
			1/2"	F-F	RRASPX1/2"FF	127,00
NRM	Valvola di ritegno / Check valve / Válvula de retención / Vanne anti-rétour		1/4"	F-F	RRANRXMO1/4FF	43,00
			1/2"	F-F	RRANRXMO1/2FF	52,00



VPO



IPV

MAN-X

FILY-X



VS2-X

SPO-X

NRM-X

Piloti di Regolazione / Regulating Pilots / Pilotos de Regulación / Pilotes de Régulation

Mod.	Tipo / Type / Tipo / Type	Reg.	PN	COD.	Euro
RP2M	Riduttore di pressione / Pressure reducing	1.0÷11 bar	16	RPIRP2M001-11	166,00
	Reductor de presión / Réducteur de pression	2.0÷23 bar	25	RPIRP2X002-18	207,00
SP2M	Sostegno pressione / Pressure sustaining	1.0÷10.0 bar	25	RPIRS2M001-10	340,00
	Sostenedor de presión / Mainteneur de pression	2.0÷23 bar	25	RPIRS2M002-20	364,00
QP2M	Regolatore di portata / Flow rate control		16	RPIQP2M000000	429,00
	Regulador de caudal / Régulateur de débit				
SR	Scarico rapido / Quick relief	1.0÷10 bar	25	RPISR3M001-10	267,00
	Alivio rápido / Décharge rapide	1.5÷22 bar	25	RPISR3M015-22	267,00
GAL	Galleggiante modulante / Modulating float	(Ø1/2")	16	RPIGAL0001/2"	75,00
	Flotador modulante / Flotteur modulante	(Ø3/4")	16	RPIGAL0003/4"	90,00
GAD1	Galleggiante differenziale / Differential float	(0,5 mt)	16	RPIGAD0501/8"	579,00
	Flotador diferencial / Flotteur différentiel				
GAD2	Galleggiante differenziale / Differential float	(1,2 mt)	16	RPIGAD0001/8"	886,00
	Flotador diferencial / Flotteur différentiel	(1,5 / 2,0 / 2,5 mt)			-----
ALT	Altimetrico / Altitude	(10 m.c.a.)	16	RPIALT3020MCA	1.065,00
	Altimétrico / Altimétrique	(20 / 30 m.c.a.)			-----
EL2	Solenoido 2 vie / 2-way solenoid	(2way-8W-N.C.-24VAC)	16	REV2O1/2"8WNC	113,00
	Solenoids de 2 vias / Solenoïde 2 voies	(2way-8W-N.C.-24VAC)	25		



RP2M

SP2M

QP2M



SR

EL2

ALT



GAL

GAD1

GAD2

ООО «ТИ-СИСТЕМС» ИНЖИНИРИНГ И ПОСТАВКА ТЕХНОЛОГИЧЕСКОГО ОБОРУДОВАНИЯ

Интернет: www.tisys.ru www.tisys.kz www.tisys.by www.tesec.ru www.ti-sistems.pf

TECNIDRO S.R.L.

www.tecnidro.com

# Hydraulic Control Valves

PN 10/16



Indicatore di Posizione  
Position Indicator  
Indicador de Posición  
Indicateur de Position



Manometri  
Pressure Gauges  
Manómetros  
Manomètres



IM  
Single Chamber

## Dimensioni & Pesì / Dimensions & Weights / Dimensiones y Pesos / Dimensions et Poids

Filettato / Threaded / Roscado / Taraudé						Q <sub>n</sub> (*)	
Ø (mm-inch)	Type	L (mm)	H (mm)	B (mm)	P (Kg)	ON-OFF (m³/h)	REGULATION (m³/h)
1"	1	116	50	70	0.9	12	25
1 1/4"	1	175	100	120	4.0	30	60
1 1/2"	1	175	100	120	3.0	33	65
2"	1	175	100	120	3.4	40	80
2" E	2	128	90	120	3.2	44	90
2 1/2"	1	200	115	120	4.0	48	95
3"C	1	230	135	165	8.2	70	150
3" E	2	188	139	150	8.0	75	160

Flangiato / Flanged / Bridado / Brides						Q <sub>n</sub> (*)	
Ø (mm-inch)	Type	L (mm)	H (mm)	B (mm)	P (Kg)	ON-OFF (m³/h)	REGULATION (m³/h)
50 - 2"	3	175	165	165	6.5	40	80
65 - 2 1/2"	3	175	165	165	8.0	48	95
80 - 3"	3	280	200	210	16.2	85	170
100 - 4"	3	300	220	220	19.5	95	195
125 - 5"	3	325	250	250	22.5	110	210
150 - 6"	3	350	320	320	41.5	190	375
200 - 8"	3	400	340	340	50.0	210	425
250 - 10"	3	450	470	405	86.0	350	700
300 - 12"	3	500	500	460	135.0	450	900
350 - 14"	4	550	520	520	155.0	750	1.600
400 - 16"	4	600	580	580	170.0	900	1.800

Type

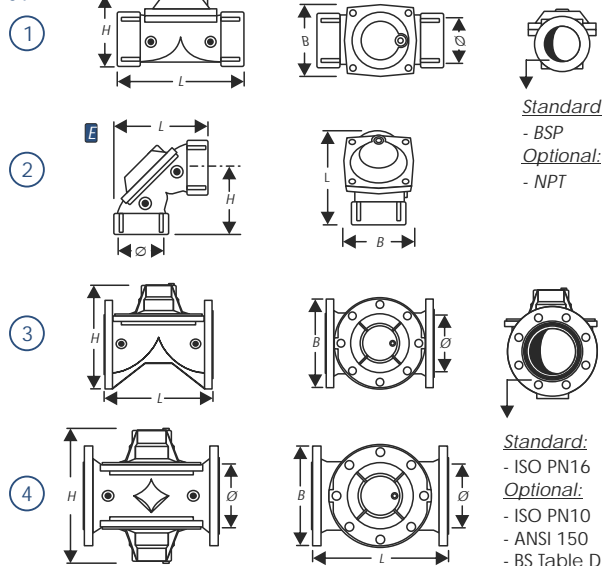

(\*) Portate Consigliate

Suggested Flow Rates / Caudales Aconsejados / Débits Conseillés  
Q<sub>n</sub> [ON-OFF] → DP = 0.2 (bar)  
Q<sub>n</sub> [REGULATION] → DP = 0.8 (bar)

DN80-3" SELECTION GUIDE	
Mod.	Q (m³/h) - Portata / Flow rate / Caudal / Débit
3"C	40 < Q < 120 Media / Medium / Medio / Moyen
3" E	50 < Q < 130 Media / Medium / Medio / Moyen
Dn80	60 < Q < 180 Alta / High / Elevado / Élevé

## Pressioni di Esercizio / Working Pressures / Presiones de Servicio / Pressions d'Exercice

Ø	Standard	Standard	
		Min (bar)	Max (bar)
1"	RIMMEM070NR50	0.8	16.0
1 1/4" - 1 1/2" - 2" - 2"E - 2 1/2" - DN50 - DN65	RIMMEM113NR60 RIMMOL0203020	1.5	16.0
3"C - 3"E	RIMMEM150NR60 RIMMOL030C045	1.5	16.0
DN80 - DN100 - DN125	RIMMEM200NR70 RIMMOL8010060	1.5	16.0
DN150 - DN200	RIMMEM294NR70 RIMMOL1520080	1.5	16.0
DN250 - DN300	RIMMEM380NR70 RIMMOL2540100	1.5	16.0

Ø	Optional	Optional	
		Min (bar)	Max (bar)
--	--	--	--
	RIMMEM113NR40 RIMMOL0203020	0.6	6.0
	RIMMEM150NR50 RIMMOL030C045	0.9	6.0
	RIMMEM200NR50 RIMMOL8010050	0.7	6.0
	RIMMEM294NR50 RIMMOL1520050	0.7	6.0
	RIMMEM380NR50 RIMMOL2540080	0.8	6.0

High Rate

	Min (bar)	Max (bar)
RIMMEM200NR80 RIMMOL8010050	6.0	16.0
RIMMEM294NR80 RIMMOL1520050	6.0	16.0





Valvola Idraulica Base / Basic Valve / Válvula Básica / Vanne Basique

FILETTATO ROSCADO	COD.	Ø		Euro
		mm	inch	
	IMAI DR00001 "M	25	1"	69,00
	IMAI DR01 "1/4M	32	1 1/4"	94,00
	IMAI DR01 "1/2M	40	1 1/2"	94,00
	IMAI DR00002 "M	50	2"	94,00
	IMAI DR0002 "EM	50	2"	103,00
	IMAI DR02 "1/2M	65	2 1/2"	133,00
	IMAI DR0003 "CM	80	3"	225,00
	IMAI DR0003 "EM	80	3"	248,00

FLANGIATO BRIDADO	COD.	Ø		Euro
		mm	inch	
	IMAI DR000050F	50	2"	210,00
	IMAI DR000065F	65	2 1/2"	233,00
	IMAI DR000080F	80	3"	341,00
	IMAI DR000100F	100	4"	479,00
	IMAI DR000125F	125	5"	484,00
	IMAI DR000150F	150	6"	1.116,00
	IMAI DR000200F	200	8"	1.730,00
	IMAI DR000250F	250	10"	2.866,00
	IMAI DR000300F	300	12"	5.929,00
	Ø 350-400 (14"-16")			-----



IM-IDR



Opzioni / Options / Opciones / Options

Indicatore di posizione / Position indicator	DN32-1 1/4" ÷ DN65-2 1/2"	Euro	67,00
Indicador de posición / Indicateur de position	DN80-3" ÷ DN125-5"	Euro	100,00
	DN150-6" ÷ DN200-8"	Euro	167,00
	DN250-10" ÷ DN300-12"	Euro	335,00

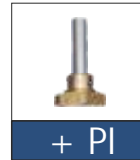

+ PI

Idraulica Manuale / Manual Valve / Válvula Manual / Vanne Manuelle

FILETTATO ROSCADO	COD.	Ø		Euro
		mm	inch	
	IMACM4V0001 "M	25	1"	96,00
	IMACM4V1 "1/4M	32	1 1/4"	122,00
	IMACM4V1 "1/2M	40	1 1/2"	122,00
	IMACM4V0002 "M	50	2"	122,00
	IMACM4V002 "EM	50	2"	130,00
	IMACM4V2 "1/2M	65	2 1/2"	160,00
	IMACM4V003 "CM	80	3"	252,00
	IMACM4V003 "EM	80	3"	275,00

FLANGIATO BRIDADO	COD.	Ø		Euro
		mm	inch	
	IMACM4V00050F	50	2"	235,00
	IMACM4V00065F	65	2 1/2"	261,00
	IMACM4V00080F	80	3"	367,00
	IMACM4V00100F	100	4"	507,00
	IMACM4V00125F	125	5"	563,00
	IMACM4V00150F	150	6"	1.159,00
	IMACM4V00200F	200	8"	1.772,00
	IMACM4V00250F	250	10"	2.909,00
	IMACM4V00300F	300	12"	5.972,00
	Ø 350-400 (14"-16")			-----



IM-CM4V

Elettroidraulica / Electrohydraulic / Electrohidráulica / Eléctro-hydraulique

FILETTATO ROSCADO	COD.	Ø		Euro
		mm	inch	
	IMAE L200001 "M	25	1"	243,00
	IMAE L201 "1/4M	32	1 1/4"	268,00
	IMAE L201 "1/2M	40	1 1/2"	268,00
	IMAE L200002 "M	50	2"	268,00
	IMAE L20002 "EM	50	2"	278,00
	IMAE L202 "1/2M	65	2 1/2"	307,00
	IMAE L20003 "CM	80	3"	400,00
	IMAE L20003 "EM	80	3"	422,00

FLANGIATO BRIDADO	COD.	Ø		Euro
		mm	inch	
	IMAE L2000050F	50	2"	384,00
	IMAE L2000065F	65	2 1/2"	409,00
	IMAE L2000080F	80	3"	514,00
	IMAE L2000100F	100	4"	653,00
	IMAE L2000125F	125	5"	711,00
	IMAE L2000150F	150	6"	1.305,00
	IMAE L2000200F	200	8"	1.916,00
	IMAE L2000250F	250	10"	3.054,00
	IMAE L2000300F	300	12"	6.116,00
	Ø 350-400 (14"-16")			-----



IM-EL2



Standard  
24V AC  
50+60 Hz  
N.C. Pn16

Optionals

24-110-220V AC/DC

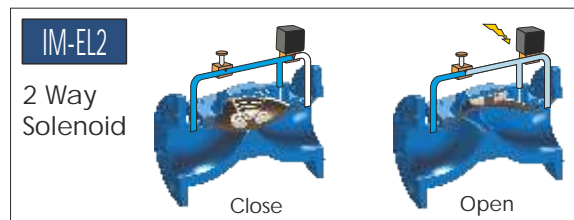

IM-EL2

2 Way Solenoid

Close

Open

Funzione 3 vie / 3 Way Function / Funciones de 3 vias / Fonctions 3 voies

IMA + E13 Solenoide 3 vie / 3-way solenoid / Solenoide de 3 vias / Solenoide 3 voies (24V AC)

Euro 27,00

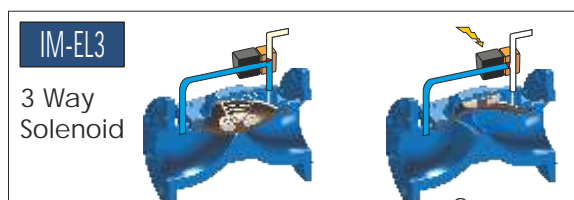

IM-EL3

3 Way Solenoid

Close

Open

ООО «ТИ-СИСТЕМС» ИНЖИНИРИНГ И ПОСТАВКА ТЕХНОЛОГИЧЕСКОГО ОБОРУДОВАНИЯ

Интернет: www.tisys.ru www.tisys.kz www.tisys.by www.tesec.ru www.ti-sistems.pc

TECNIDRO S.R.L.

www.tecnidro.com

14

Телефоны: +7 (495) 7774788, 7489626, 5007155, 54 Эл. почта: info@tisys.ru info@tisys.kz info@tisys.by

Riduzione Pressione / Pressure Reducing / Reductoras de Presión / Réduction de Pression



IM-RP2M

**Standard**  
1,0÷11,0 bar  
Pn16  
2-WAY

COD.	Ø		Euro
	mm	inch	
IMARP2M0001*M	25	1"	269,00
IMARP2M1"1/4M	32	1"¼	295,00
IMARP2M1"1/2M	40	1"½	295,00
IMARP2M0002*M	50	2"	295,00
IMARP2M002*EM	50	2"	303,00
IMARP2M2"1/2M	65	2"½	333,00
IMARP2M003*CM	80	3"	425,00
IMARP2M003*EM	80	3"	448,00

FILETTATO  
ROSCADO



Funzioni Aggiuntive / Additional Functions / Funciones Adicionales / Fonctions Supplémentaires

IM-RP2M + **EL2** Solenoide 2 vie / 2-way solenoid  
Solenóide de 2 vías / Solenoide 2 voies (24V AC Pn16) **Euro 119,00**

COD.	Ø		Euro
	mm	inch	
IMARP2M00050F	50	2"	409,00
IMARP2M00065F	65	2"½	43,00
IMARP2M00080F	80	3"	541,00
IMARP2M00100F	100	4"	679,00
IMARP2M00125F	125	5"	738,00
IMARP2M00150F	150	6"	1.441,00
IMARP2M00200F	200	8"	2.052,00
IMARP2M00250F	250	10"	3.191,00
IMARP2M00300F	300	12"	6.253,00
Ø 350-400 (14"-16")			-----

FLANGIATO  
BRIDADO

Sostegno Pressione / Pressure Sustaining / Sostenedoras de Presión / Mainteneur de Pression



IM-SP2M

**Standard**      **Optionals**  
1,0÷10,0 bar      2,0÷20,0 bar  
Pn16  
2 WAY

COD.	Ø		Euro
	mm	inch	
IMASP2M0001*M	25	1"	354,00
IMASP2M1"1/4M	32	1"¼	379,00
IMASP2M1"1/2M	40	1"½	379,00
IMASP2M0002*M	50	2"	379,00
IMASP2M002*EM	50	2"	388,00
IMASP2M2"1/2M	65	2"½	419,00
IMASP2M003*CM	80	3"	511,00
IMASP2M003*EM	80	3"	533,00

FILETTATO  
ROSCADO



Funzioni Aggiuntive / Additional Functions / Funciones Adicionales / Fonctions Supplémentaires

IM-SP2M + **EL2** Solenoide 2 vie / 2-way solenoid  
Solenóide de 2 vías / Solenoide 2 voies (24V AC Pn10) **Euro 119,00**  
IM-SP2M + **RP2M** Pilota riduttore di pressione / Pressure reducing pilot  
Piloto reductor de presión / Pilote réducteur de pression **Euro 156,00**

COD.	Ø		Euro
	mm	inch	
IMASP2M00050F	50	2"	495,00
IMASP2M00065F	65	2"½	520,00
IMASP2M00080F	80	3"	625,00
IMASP2M00100F	100	4"	763,00
IMASP2M00125F	125	5"	823,00
IMASP2M00150F	150	6"	1.429,00
IMASP2M00200F	200	8"	2.042,00
IMASP2M00250F	250	10"	3.179,00
IMASP2M00300F	300	12"	6.241,00
Ø 350-400 (14"-16")			-----

FLANGIATO  
BRIDADO

Regolazione Portata / Flow Rate Control / Reguladora de Caudal / Contrôle de Débit



IM-QP2M

COD.	Ø		Euro
	mm	inch	
IMAQP2M0001*M	25	1"	621,00
IMAQP2M1"1/4M	32	1"¼	648,00
IMAQP2M1"1/2M	40	1"½	648,00
IMAQP2M0002*M	50	2"	648,00
IMAQP2M002*EM	50	2"	656,00
IMAQP2M2"1/2M	65	2"½	687,00
IMAQP2M003*CM	80	3"	779,00
IMAQP2M003*EM	80	3"	801,00

FILETTATO  
ROSCADO



Funzioni Aggiuntive / Additional Functions / Funciones Adicionales / Fonctions Supplémentaires

IM-QP2M + **EL2** Solenoide 2 vie / 2-way solenoid  
Solenóide de 2 vías / Solenoide 2 voies (24V AC Pn10) **Euro 119,00**  
IM-QP2M + **RP2M** Pilota riduttore di pressione / Pressure reducing pilot  
Piloto reductor de presión / Pilote réducteur de pression **Euro 156,00**

COD.	Ø		Euro
	mm	inch	
IMAQP2M00050F	50	2"	762,00
IMAQP2M00065F	65	2"½	788,00
IMAQP2M00080F	80	3"	894,00
IMAQP2M00100F	100	4"	1.031,00
IMAQP2M00125F	125	5"	1.091,00
IMAQP2M00150F	150	6"	1.923,00
IMAQP2M00200F	200	8"	2.536,00
IMAQP2M00250F	250	10"	3.673,00
IMAQP2M00300F	300	12"	6.735,00
Ø 350-400 (14"-16")			-----

FLANGIATO  
BRIDADO

Funzioni 3 Vie / 3-Way Functions / Funciones de 3 Vías / Fonctions 3 Voies

- IM + **RP3B** Riduzionei pressione / Pressure reducing / Reductoras de presión / Réduction de pression **Euro 101,00**
- IM + **SP3B** Sostegno pressione / Pressure sustaining / Sostenedoras de presión / Mainteneur de pression **Euro 101,00**
- IM + **QP3B** Regolazione portata / Flow rate control / Reguladora de caudal / Contrôle de Débit **Euro 101,00**

ООО «ТИ-СИСТЕМС» ИНЖИНИРИНГ И ПОСТАВКА ТЕХНОЛОГИЧЕСКОГО ОБОРУДОВАНИЯ

Интернет: www.tisys.ru www.tisys.kz www.tisys.by www.tesec.ru www.ti-sistems.pl

www.tecnidro.com

TECNIDRO S.R.L.

Телефоны: +7 (495) 7774788, 7489626, 5007155, 54 Эл. почта: info@tisys.ru info@tisys.kz info@tisys.by

FILETTATO ROSCADO	THREADED TARAUDÉ	COD.	Ø		Euro
			mm	inch	
		IMASR000001*M	25	1"	382,00
		IMASR001*1/4M	32	1"¼	407,00
		IMASR001*1/2M	40	1"½	407,00
		IMASR000002*M	50	2"	407,00
		IMASR00002*EM	50	2"	416,00
		IMASR002*1/2M	65	2"½	445,00
		IMASR00003*CM	80	3"	537,00
		IMASR00003*EM	80	3"	560,00

FLANGIATO BRIDADO	FLANGED BRIDES	COD.	Ø		Euro	
			mm	inch		
		IMASR0000050F	50	2"	520,00	
		IMASR0000065F	65	2"½	546,00	
		IMASR0000080F	80	3"	652,00	
		IMASR0000100F	100	4"	790,00	
		IMASR0000125F	125	5"	848,00	
		IMASR0000150F	150	6"	1.462,00	
		IMASR0000200F	200	8"	2.073,00	
		IMASR0000250F	250	10"	3.210,00	
		IMASR0000300F	300	12"	6.273,00	
		Ø 350-400 (14"-16")				-----



**IM-SR**

	<b>Standard</b>	<b>Optionals</b>
	1,0÷10,0 bar Pn16	1,5÷22,0 bar

Controllo Pompa / Pump Control / Control de Bomba / Contrôle de Pompe

FILETTATO ROSCADO	THREADED TARAUDÉ	COD.	Ø		Euro
			mm	inch	

FLANGIATO BRIDADO	FLANGED BRIDES	COD.	Ø		Euro	
			mm	inch		
		IMACP0000050F	50	2"	930,00	
		IMACP0000065F	65	2"½	955,00	
		IMACP0000080F	80	3"	1.060,00	
		IMACP0000100F	100	4"	1.199,00	
		IMACP0000125F	125	5"	1.257,00	
		IMACP0000150F	150	6"	1.922,00	
		IMACP0000200F	200	8"	2.534,00	
		IMACP0000250F	250	10"	3.671,00	
		IMACP0000300F	300	12"	6.734,00	
		Ø 350-400 (14"-16")				-----



**IM-CP**

	<b>Standard</b>	<b>Optionals</b>
	24V AC 50/60 Hz N.C. Pn16	24-110-220V AC/DC
	220V AC 50/60 Hz N.C.	24-110-220V AC/DC

Ritegno Automatico / Automatic Check / Retención Automática / Anti-rétour Automatique

FILETTATO ROSCADO	THREADED TARAUDÉ	COD.	Ø		Euro
			mm	inch	
		IMANR000001*M	25	1"	143,00
		IMANR001*1/4M	32	1"¼	169,00
		IMANR001*1/2M	40	1"½	169,00
		IMANR000002*M	50	2"	169,00
		IMANR00002*EM	50	2"	170,00
		IMANR002*1/2M	65	2"½	198,00
		IMANR00003*CM	80	3"	300,00
		IMANR00003*EM	80	3"	321,00

FLANGIATO BRIDADO	FLANGED BRIDES	COD.	Ø		Euro	
			mm	inch		
		IMANR0000050F	50	2"	283,00	
		IMANR0000065F	65	2"½	308,00	
		IMANR0000080F	80	3"	413,00	
		IMANR0000100F	100	4"	553,00	
		IMANR0000125F	125	5"	612,00	
		IMANR0000150F	150	6"	1.213,00	
		IMANR0000200F	200	8"	1.826,00	
		IMANR0000250F	250	10"	2.963,00	
		IMANR0000300F	300	12"	6.026,00	
		Ø 350-400 (14"-16")				-----



**IM-NR**

/ Pressure Reducing 2 Levels / Reductoras De Presion 2 Niveles

Riduzione Pressione due livelli / Réduction de Pression 2 Niveaux

FILETTATO ROSCADO	THREADED TARAUDÉ	COD.	Ø		Euro
			mm	inch	

FLANGIATO BRIDADO	FLANGED BRIDES	COD.	Ø		Euro	
			mm	inch		
		IMARP2L00050F	50	2"	836,00	
		IMARP2L00065F	65	2"½	863,00	
		IMARP2L00080F	80	3"	968,00	
		IMARP2L00100F	100	4"	1.107,00	
		IMARP2L00125F	125	5"	1.165,00	
		IMARP2L00150F	150	6"	1.868,00	
		IMARP2L00200F	200	8"	2.479,00	
		IMARP2L00250F	250	10"	3.618,00	
		IMARP2L00300F	300	12"	6.680,00	
		Ø 350-400 (14"-16")				-----



**IM-RP-2L**



**IM-GAL**

Standard Pn16 PP  
Optionals Inox

COD.	Ø		Euro
	mm	inch	
IMAGAL00001*M	25	1"	193,00
IMAGAL01*1/4M	32	1 1/4"	218,00
IMAGAL01*1/2M	40	1 1/2"	218,00
IMAGAL00002*M	50	2"	218,00
IMAGAL0002*EM	50	2"	236,00
IMAGAL02*1/2M	65	2 1/2"	258,00
IMAGAL0003*CM	80	3"	350,00
IMAGAL0003*EM	80	3"	371,00

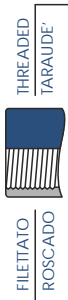

COD.	Ø		Euro
	mm	inch	
IMAGAL000050F	50	2"	333,00
IMAGAL000065F	65	2 1/2"	358,00
IMAGAL000080F	80	3"	463,00
IMAGAL000100F	100	4"	603,00
IMAGAL000125F	125	5"	660,00
IMAGAL000150F	150	6"	1.317,00
IMAGAL000200F	200	8"	1.928,00
IMAGAL000250F	250	10"	3.067,00
IMAGAL000300F	300	12"	6.130,00
Ø 350-400 (14"-16")			-----

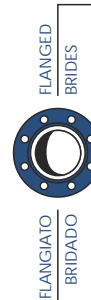

**Funzioni Aggiuntive / Additional Functions / Funciones Adicionales / Fonctions Supplémentaires**



**IM-GAL + EL2** Solenoide 2 vie / 2-way solenoid  
Solenoido de 2 vías / Solenoide 2 voies (24V AC Pn16) **Euro 119,00**

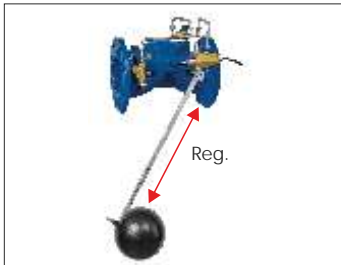

**IM-GAD1**

Standard 0,5 mt Pn16 PP  
Optionals Inox

COD.	Ø		Euro
	mm	inch	
IMAGAD10001*M	25	1"	750,00
IMAGAD11*1/4M	32	1 1/4"	776,00
IMAGAD11*1/2M	40	1 1/2"	776,00
IMAGAD10002*M	50	2"	776,00
IMAGAD1002*EM	50	2"	784,00
IMAGAD12*1/2M	65	2 1/2"	814,00
IMAGAD1003*CM	80	3"	906,00
IMAGAD1003*EM	80	3"	930,00

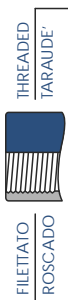

COD.	Ø		Euro
	mm	inch	
IMAGAD100050F	50	2"	890,00
IMAGAD100065F	65	2 1/2"	919,00
IMAGAD100080F	80	3"	1.022,00
IMAGAD100100F	100	4"	1.161,00
IMAGAD100125F	125	5"	1.219,00
IMAGAD100150F	150	6"	1.827,00
IMAGAD100200F	200	8"	2.441,00
IMAGAD100250F	250	10"	3.578,00
IMAGAD100300F	300	12"	6.357,00
Ø 350-400 (14"-16")			-----



**IM-GAD2**

Standard 1,2 mt Pn16 INOX  
Optionals 1,5 / 2,0 / 2,5 mt

COD.	Ø		Euro
	mm	inch	
IMAGAD20001*M	25	1"	944,00
IMAGAD21*1/4M	32	1 1/4"	969,00
IMAGAD21*1/2M	40	1 1/2"	969,00
IMAGAD20002*M	50	2"	969,00
IMAGAD2002*EM	50	2"	978,00
IMAGAD22*1/2M	65	2 1/2"	1.009,00
IMAGAD2003*CM	80	3"	1.101,00
IMAGAD2003*EM	80	3"	1.123,00



COD.	Ø		Euro
	mm	inch	
IMAGAD200050F	50	2"	1.083,00
IMAGAD200065F	65	2 1/2"	1.110,00
IMAGAD200080F	80	3"	1.216,00
IMAGAD200100F	100	4"	1.354,00
IMAGAD200125F	125	5"	1.412,00
IMAGAD200150F	150	6"	2.022,00
IMAGAD200200F	200	8"	2.634,00
IMAGAD200250F	250	10"	3.770,00
IMAGAD200300F	300	12"	6.834,00
Ø 350-400 (14"-16")			-----

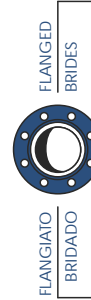

**Controllo Altimetrico / Altimetric Control / Control Altimetrico / Contrôle Altimétrique**



**IM-ALT**

Standard Pn16 1 ÷ 10 m.c.a.  
Optionals 8 ÷ 20 / 18 ÷ 30 m.c.a.

COD.	Ø		Euro
	mm	inch	
IMAALT00001*M	25	1"	1.230,00
IMAALT01*1/4M	32	1 1/4"	1.256,00
IMAALT01*1/2M	40	1 1/2"	1.256,00
IMAALT00002*M	50	2"	1.256,00
IMAALT0002*EM	50	2"	1.265,00
IMAALT02*1/2M	65	2 1/2"	1.294,00
IMAALT0003*CM	80	3"	1.386,00
IMAALT0003*EM	80	3"	1.409,00

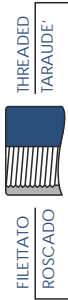

COD.	Ø		Euro
	mm	inch	
IMAALT000050F	50	2"	1.403,00
IMAALT000065F	65	2 1/2"	1.428,00
IMAALT000080F	80	3"	1.428,00
IMAALT000100F	100	4"	1.427,00
IMAALT000125F	125	5"	1.698,00
IMAALT000150F	150	6"	2.308,00
IMAALT000200F	200	8"	2.920,00
IMAALT000250F	250	10"	4.058,00
IMAALT000300F	300	12"	7.120,00
Ø 350-400 (14"-16")			-----

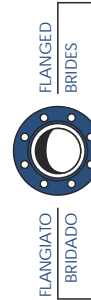

**Funzioni Aggiuntive / Additional Functions / Funciones Adicionales / Fonctions Supplémentaires**



**IM-ALT + EL2** Solenoide 2 vie / 2-way solenoid  
Solenoido de 2 vías / Solenoide 2 voies (24V AC Pn16) **Euro 119,00**



ООО «ТИ-СИСТЕМС» ИНЖИНИРИНГ И ПОСТАВКА ТЕХНОЛОГИЧЕСКОГО ОБОРУДОВАНИЯ

Mod.	Tipo / Type / Tipo / Type	Size	PN	COD.	Euro
RP2M	Riduttore di pressione / Pressure reducing Reductor de presión / Réducteur de pression	1.0÷11 bar	16	RPIRP2M001-11	166,00
SP2M	Sostegno pressione / Pressure sustaining	1.0÷10.0 bar	16	RPIRS2M001-10	340,00
" "	Sostenedor de presión / Mainteneur de pression	2.0÷20.0 bar	16	RPISP2M002-20	364,00
QP2M	Regolatore di portata / Flow rate control Regulador de caudal / Régulateur de débit		16	RPIQP2M000000	429,00
RP3B	Riduttore di pressione / Pressure reducing	0.2÷1.5 bar	16	RPIRP3B002-15	150,00
" "	Reductor de presión / Réducteur de pression	0.2÷3.0 bar	16	RPIRP3B0002-3	150,00
" "		1.0÷5.5 bar	16	RPIRP3B001-55	150,00
" "		1.0÷9.0 bar	16	RPIRP3B0001-9	150,00
SP3B	Sostegno pressione / Pressure sustaining	0.2÷1.5 bar	16	RPISP3B002-15	150,00
" "	Sostenedor de presión / Mainteneur de pression	0.2÷3.0 bar	16	RPISP3B0002-3	150,00
" "		1.0÷5.5 bar	16	RPISP3B001-55	150,00
" "		1.0÷9.0 bar	16	RPISP3B0001-9	150,00
QP3B	Regolatore di portata / Flow rate control Regulador de caudal / Régulateur de débit		16	RPIQP3B000000	216,00
SR	Scarico rapido / Quick relief	1.0÷10 bar	25	RPISR3M001-10	267,00
" "	Alivio rápido / Décharge rapide	6.0÷22 bar	25	RPISR3M060-22	267,00
GAL	Galleggiante modulante / Modulating float	(Ø1/2")	16	RPIGAL0001/2"	75,00
" "	Flotador modulante / Flotteur modulante	(Ø3/4")	16	RPIGAL0003/4"	90,00
GAD1	Galleggiante differenziale / Differential float Flotador diferencial / Flotteur différentiel	(0÷0,5 mt)	16	RPIGAD0501/8"	579,00
GAD2	Galleggiante differenziale / Differential float Flotador diferencial / Flotteur différentiel	(0÷1,2 mt) (1,5 / 2,0 / 2,5 mt)	16	RPIGAD0001/8"	886,00 ----
ALT	Altimetrico / Altitude Altimétrico / Altimétrique	(10 m.c.a.) (20 / 30 m.c.a.)	16	RPIALT3020MCA	1.065,00 ----
EL2	Solenoido 2 vie / 2-way solenoid Solenoido de 2 vías / Solenoïde 2 voies	(Ø1/2"-8W-N.C.-24VAC)	16	REV2O1/2"8WNC	113,00
EI3	Solenoido 3 Vie / 3-way solenoid Solenoido de 3 vías / Solenoïde 3 voies	(Ø1/8"-8W-N.O.-24VAC)	16	REV3O1/8"8WOU	102,00
FILY	Filtro a "Y" / "Y" strainer Filtro de "Y" / Filtre à "Y"	F-F 1/4"	16	RRAFILYO1/4"M	17,00
VS2	Valvola a sfera / Ball valve Válvula de esfera / Vanne à sphère	M-F 1/4"	16	RRAVS2VO1/4MF	13,00
MAN	Manometro / Pressure gauge Manómetro / Manomètre	M 1/4"	16	RRAMAP4R06316	29,00
NRM	Valvola di ritegno / Check valve Válvula de retención / Vanne anti-rétour	F-F 1/4"	16	RRANROMO1/4FF	45,00
SPO	Valvola a spillo / Needle valve Válvula de aguja / Robinet pointeau	F-F 1/4"	16	RRASPO01/4"FF	62,00
CM4V	Rubinetto a 3 vie / 3-way manual handle Mando manual de 3 vías / Robinet 3 voies	M-F-F-F 1/4"x1/8"	16	RRACM4VO1/4"M	16,00
MSW	Fine corsa / Microswitch Final de carrera / Fin de course	(0÷230V ac 50÷60 Hz)		RRAMSWT220VAC	381,00



Parti di Ricambio / Refill Parts / Piezas de Repuesto / Pièces de Réchange

SIZE (Ø)	Membrane / Diaphragms Membranas / Membranes	Sh	Euro	Molle / Springs Muelles / Ressorts	Ø	Euro	Supporti / Supports Soportes / Supports	Euro
1"	RIMMEM070NR50	50	20,00	-	-	-	-	-
1"1/4 - 1"1/2 - 2" - 2"E	RIMMEM113NR40	40	33,00	RIMMOL0203020	20	6,00	RIMSUP002-003	5,00
2"1/2 - DN50 - DN65	RIMMEM113NR60	60	33,00	RIMMOL0203030	30	6,00	" " "	"
3"C - 3"E	RIMMEM150NR50	50	48,00	RIMMOL030C045	45	13,00	RIMSUP003-00C	12,00
	RIMMEM150NR60	60	48,00	" " "	"	"	" " "	"
DN80 - DN100	RIMMEM200NR50	50	85,00	RIMMOL8010050	50	42,00	RIMSUP080-100	15,00
DN125	RIMMEM200NR70	70	85,00	RIMMOL8010060	60	42,00	" " "	"
	RIMMEM200NR80	80	94,00	RIMMOL8010060	60	42,00	" " "	"
DN150 - DN200	RIMMEM294NR50	50	167,00	RIMMOL1520050	50	78,00	RIMSUP150-200	26,00
	RIMMEM294NR70	70	167,00	RIMMOL1520080	80	78,00	" " "	"
	RIMMEM294NR80	80	184,00	RIMMOL1520080	80	78,00	" " "	"
DN250 - DN300	RIMMEM380NR50	50	333,00	RIMMOL2540080	80	168,00	RIMSUP250-400	58,00
	RIMMEM380NR70	70	333,00	RIMMOL2540100	100	168,00	" " "	"
<b>Molle piloti / Pilot's springs / Muelles pilotos / Ressorts pilotes</b>								Euro
RP3B/SP3B	RIMMOLRP3B215 - RIMMOLRP3B230 - RIMMOLRP3B155 - RIMMOLRP3B190							9,00
QP3B	RIMMOLRP3B215							9,00



IN Series  
(Nylon/PP)



IP Series  
(uPVC)



VHF - Very High Flow Control Valves

PN 10



VHF  
Single Chamber

IN/IP-F Series



Dimensioni & Pesì

/ Dimensions & Weights / Dimensiones y Pesos / Dimensions et Poids

Modelli e Conessioni

/ Type & Connections / Modelos y Conexiones / Types et Connexions

IN Series - Filettato / Threaded / Roscado / Taraudé						Q <sub>n</sub> (*)	
Ø (inch)	Type	L (mm)	H (mm)	B (mm)	P (Kg)	ON-OFF (m³/h)	REGULATION (m³/h)
Ø1½	1	175	120	122	0.9	30	62
Ø2"	1	175	120	122	0.9	30	62
Ø3"A	2	260	140	125	1.0	39	79
Ø3"F	5	345	227	280	3.2	100	200
Ø4"F	5	345	227	280	3.3	112	227
Ø6"D <sup>(1)</sup>	6	290	315	205	5.6	140	250

(1) Conessioni scanalate / Grooved end connections / Conexiones ranuradas / Connexions rainurées

IN-F Series - Filettato / Threaded / Roscadas / Taraudé						Q <sub>n</sub> (*)	
Ø (inch)	Type	L (mm)	H/H' (mm)	B (mm)	P (Kg)	ON-OFF (m³/h)	REGULATION (m³/h)
Ø1½	3	175	210/180	122	1.0	30	62
Ø2"	3	175	210/180	122	1.0	30	62
Ø3"A	4	260	230/200	125	1.1	39	79

IP Series - Incollaggio / Solvent cement / Encolar / À coller						Q <sub>n</sub> (*)	
Ø (inch)	Type	L (mm)	H (mm)	B (mm)	P (Kg)	ON-OFF (m³/h)	REGULATION (m³/h)
Ø63-2"	1	175	120	122	0.9	30	62
Ø90R-3"	2	260	140	125	1.0	39	79
Ø90-3"	5	345	227	280	3.2	100	200
Ø110-4"	5	345	227	280	3.3	112	227

IP-F Series - Incollaggio / Solvent cement / Encolar / À coller						Q <sub>n</sub> (*)	
Ø (inch)	Type	L (mm)	H/H' (mm)	B (mm)	P (Kg)	ON-OFF (m³/h)	REGULATION (m³/h)
Ø63-2"	3	175	210/180	122	1.0	30	62
Ø90R-3"	4	260	230/200	125	1.1	39	79

Type

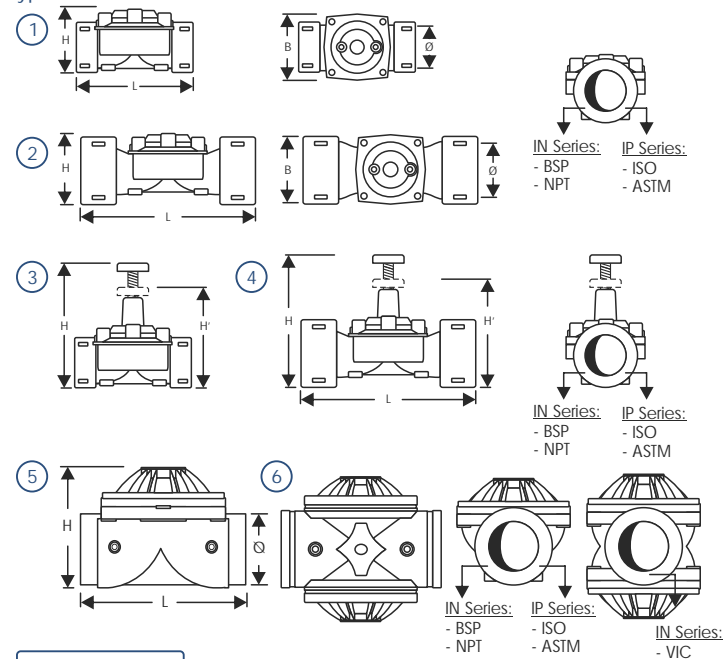

Flange Adapters

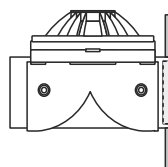

Series	Adapters	Flanges
IN/IN-F	DN80-3"BSP M / DN100-4"BSP M	ISO PN10
IP/IP-F	DN80-3"ASTM / DN100-4"ASTM	ANSI 150

Pressioni di Esercizio

/ Working Pressures / Presiones de Servicio / Pressions d'Exercice

Portate Consigliate

/ Suggested Flow Rates / Caudales Aconsejados / Débits Conseillés

Q<sub>n</sub> [ON-OFF] → P = 0.2 (bar)  
Q<sub>n</sub> [REGULATION] → P = 0.8 (bar)

Ø	Standard	Min (bar)	Max (bar)
1½ - 2" - Ø63 - 3"A - Ø90R	RIPMEM113NR40 RIPMOL0203020	0.6	10.0
3"F - Ø90 - DN80 - 4"F - Ø110 - DN100	RIPMEM265NR60	1.5	10.0



Ø90-3" SELECTION GUIDE	
Mod.	Q (m³/h) - Portata / Flow rate / Caudal / Débit
Ø3"A / Ø90-3" R	20 < Q < 90 Bassa / Low / Bajo / Faible
Ø3"F / Ø90-3" R	20 < Q < 90 Bassa / Low / Bajo / Faible
Ø3"F / Ø90-3" R	20 < Q < 90 Bassa / Low / Bajo / Faible
Ø3"F / Ø90-3" R	20 < Q < 90 Bassa / Low / Bajo / Faible

ООО «ТИ-СИСТЕМС» ИНЖИНИРИНГ И ПОСТАВКА ТЕХНОЛОГИЧЕСКОГО ОБОРУДОВАНИЯ

Интернет: www.tisys.ru www.tisys.kz www.tisys.by www.tesec.ru www.ti-sistems.pl

Телефоны: +7 (495) 7774788, 7489626, 5007155, 54 Эл. почта: info@tisys.ru info@tisys.kz info@tisys.by

Valvola Idraulica Base / Basic Valve / Válvula Básica / Vanne Basique

Nylon/PP

	COD.	Ø		Euro		COD.	Ø		Euro	
		mm	inch				mm	inch		
FILETTATO THREADED ROSCADO TARAUDE'	BSP	INIIDR01"1/2M	40	1"1/2	60,00	NPT	INIIDR01"1/2N	40	1"1/2	60,00
		INIIDR00002"M	50	2"	61,00		INIIDR00002"N	50	2"	61,00
		INIIDR00003"AM	80	3"	95,00		INIIDR00003"AN	80	3"	95,00
		INIIDR00003"FM	80	3"	231,00		INIIDR00003"FN	80	3"	231,00
		INIIDR00004"FM	100	4"	268,00		INIIDR00004"FN	100	4"	268,00
		INIIDR00006"DG	150	6"	992,00					

IN	BSP	INIF0001"1/2M	40	1"1/2	80,00	NPT	INIF0001"1/2N	40	1"1/2	80,00
		INIF0000002"M	50	2"	81,00		INIF0000002"N	50	2"	81,00
		INIF0000003"AM	80	3"	115,00		INIF0000003"AN	80	3"	115,00

	COD.	Ø		Euro		COD.	Ø		Euro	
		mm	inch				mm	inch		
INCOLLAGGIO SOLV. CEMENT ENCOLAJE A' COLLER	ISO	IPIIDR00002"1	63		50,00	ASTM	IPIIDR00002"W	2"		50,00
		IPIIDR00003"AI	90		83,00		IPIIDR00003"AW	3"		83,00
		IPIIDR00003"FI	90		221,00		IPIIDR00003"FW	3"		221,00
		IPIIDR00004"FI	110		255,00		IPIIDR00004"FW	4"		255,00

IP	ISO	IPIF0000002"1	63		71,00	ASTM	IPIF0000002"W	2"		71,00
		IPIF0000003"AI	90		105,00		IPIF0000003"AW	3"		105,00



Elettroidraulica / Electrohydraulic / Electrohidráulica / Eléctro-hydraulique

	COD.	Ø		Euro		COD.	Ø		Euro	
		mm	inch				mm	inch		
FILETTATO THREADED ROSCADO TARAUDE'	BSP	INIEL001"1/2M	40	1"1/2	95,00	NPT	INIEL001"1/2N	40	1"1/2	95,00
		INIEL000002"M	50	2"	96,00		INIEL000002"N	50	2"	96,00
		INIEL000003"AM	80	3"	130,00		INIEL000003"AN	80	3"	130,00
		INIEL000003"FM	80	3"	266,00		INIEL000003"FN	80	3"	266,00
		INIEL000004"FM	100	4"	303,00		INIEL000004"FN	100	4"	303,00

BSP		INIFEL00001"M	25	1"	31,00	NPT	-----	--	----	
		INIFEL01"1/2M	40	1"1/2	115,00		INIFEL01"1/2N	40	1"1/2	115,00
		INIFEL00002"M	50	2"	116,00		INIFEL00002"N	50	2"	116,00
		INIFEL00003"AM	80	3"	150,00		INIFEL00003"AN	80	3"	150,00

	COD.	Ø		Euro		COD.	Ø		Euro	
		mm	inch				mm	inch		
INCOLLAGGIO SOLV. CEMENT ENCOLAJE A' COLLER	ISO	IPIEL000002"1	63		85,00	ASTM	IPIEL000002"W	2"		85,00
		IPIEL00003"AI	90		118,00		IPIEL00003"AW	3"		118,00
		IPIEL00003"FI	90		256,00		IPIEL00003"FW	3"		256,00
		IPIEL00004"FI	110		290,00		IPIEL00004"FW	4"		290,00

ISO		IPIFEL00002"1	63		106,00	ASTM	IPIFEL00002"W	2"		106,00
		IPIFEL00003"AI	90		140,00		IPIFEL00003"AW	3"		140,00

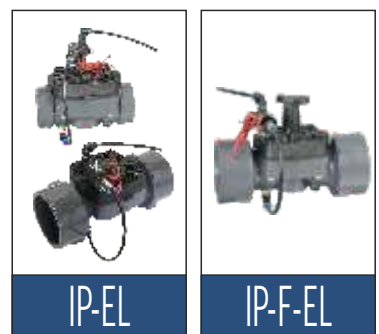
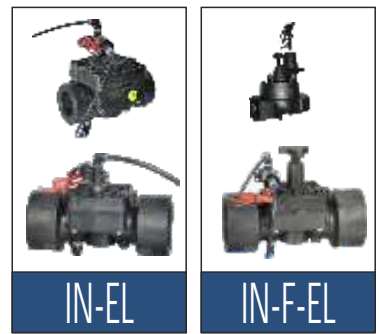

Funzioni Aggiuntive / Additional Functions / Funciones Adicionales / Fonctions Supplémentaires

+	IN/IP-EL + CM4V	Comando manuale a 3 vie / 3-way manual handle Mando manual de 3 vias / Robinet 3 voies	Euro	19,00
+	IN/IP-EL + -BI	Solenoide bistabile / Latch solenoid Solenoide latch / Solenoide latch (9-12V DC PN10)	Euro	13,00

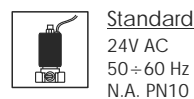

Idraulica Manuale / Manual Valve / Válvula Manual / Vanne Manuelle

	COD.	Ø		Euro		COD.	Ø		Euro	
		mm	inch				mm	inch		
FILETTATO THREADED ROSCADO TARAUDE'	BSP	INICM4V1"1/2M	40	1"1/2	82,00	NPT	INICM4V1"1/2N	40	1"1/2	82,00
		INICM4V0002"M	50	2"	83,00		INICM4V0002"N	50	2"	83,00
		INICM4V0003"AM	80	3"	117,00		INICM4V0003"AN	80	3"	117,00
		INICM4V0003"FM	80	3"	253,00		INICM4V0003"FN	80	3"	253,00
		INICM4V0004"FM	100	4"	290,00		INICM4V0004"FN	100	4"	290,00

	COD.	Ø		Euro		COD.	Ø		Euro	
		mm	inch				mm	inch		
INCOLLAGGIO SOLV. CEMENT ENCOLAJE A' COLLER	ISO	IPICM4V0002"1	63		72,00	ASTM	IPICM4V0002"W	2"		72,00
		IPICM4V0003"AI	90		105,00		IPICM4V0003"AW	3"		105,00
		IPICM4V0003"FI	90		243,00		IPICM4V0003"FW	3"		243,00





IN-SH

Nylon/PP

FILETTATO  
THREADED  
ROSCADO  
TARAUDE'



COD.	Ø		Euro
	mm	inch	
BSP INISH001"1/2M	40	1"1/2	150,00
BSP INISH00002"M	50	2"	151,00
BSP INISH00003"AM	80	3"	185,00
BSP INISH00003"FM	80	3"	321,00
BSP INISH00004"FM	100	4"	358,00

COD.	Ø		Euro
	mm	inch	
NPT INISH001"1/2N	40	1"1/2	150,00
NPT INISH00002"N	50	2"	151,00
NPT INISH00003"AN	80	3"	185,00
NPT INISH00003"FN	80	3"	321,00
NPT INISH00004"FN	100	4"	358,00



IP-SH

uPVC

INCOLLAGGIO  
SOLV. CEMENT  
ENCOLAJE  
A' COLLER



COD.	Ø		Euro
	mm	inch	
ISO IPISH000002"I	63		140,00
ISO IPISH00003"AI	90		173,00
ISO IPISH00003"FI	90		311,00
ISO IPISH00004"FI	110		345,00

COD.	Ø		Euro
	inch		
ASTM IPISH000002"W	2"		140,00
ASTM IPISH00003"AW	3"		173,00
ASTM IPISH00003"FW	3"		311,00
ASTM IPISH00004"FW	4"		345,00

Standard	Optionals
N.O. & N.C	
PN10	20 m.c.a
10 m.c.a.	2 m.c.a



IN/IP-SH + RP3PP

Pilota riduttore di pressione / Pressure reducing pilot  
Piloto reductor de presión / Pilote réducteur de pression

Euro 92,00

Funzioni Aggiuntive / Additional Functions / Funciones Adicionales / Fonctions Supplémentaires

Programmabile / Programmable / Programable / Programmable



IN-PROG

Nylon/PP

FILETTATO  
THREADED  
ROSCADO  
TARAUDE'



COD.	Ø		Euro
	mm	inch	
BSP INIPROG1"1/2M	40	1"1/2	213,00
BSP INIPROG0002"M	50	2"	214,00
BSP INIPROG003"AM	80	3"	248,00
BSP INIPROG003"FM	80	3"	384,00
BSP INIPROG004"FM	100	4"	421,00

COD.	Ø		Euro
	mm	inch	
NPT INIPROG1"1/2N	40	1"1/2	213,00
NPT INIPROG0002"N	50	2"	214,00
NPT INIPROG003"AN	80	3"	248,00
NPT INIPROG003"FN	80	3"	384,00
NPT INIPROG004"FN	100	4"	421,00



IP-PROG

uPVC

INCOLLAGGIO  
SOLV. CEMENT  
ENCOLAJE  
A' COLLER



COD.	Ø		Euro
	mm	inch	
ISO IPIPROG0002"I	63		203,00
ISO IPIPROG003"AI	90		236,00
ISO IPIPROG003"FI	90		374,00
ISO IPIPROG004"FI	110		408,00

COD.	Ø		Euro
	inch		
ASTM IPIPROG0002"W	2"		203,00
ASTM IPIPROG003"AW	3"		236,00
ASTM IPIPROG003"FW	3"		374,00
ASTM IPIPROG004"FW	4"		408,00

Riduzione Pressione / Pressure Reducing / Reductoras de Presión / Réduction de Pression



IN/IN-F-RP3PP

Nylon/PP

FILETTATO  
THREADED  
ROSCADO  
TARAUDE'



COD.	Ø		Euro
	mm	inch	
BSP INIRP3PP1"12M	40	1"1/2	138,00
BSP INIRP3PP002"M	50	2"	139,00
BSP INIRP3PP03"AM	80	3"	173,00
BSP INIRP3PP03"FM	80	3"	309,00
BSP INIRP3PP04"FM	100	4"	346,00

COD.	Ø		Euro
	mm	inch	
NPT INIRP3PP1"12N	40	1"1/2	138,00
NPT INIRP3PP002"N	50	2"	139,00
NPT INIRP3PP03"AN	80	3"	173,00
NPT INIRP3PP03"FN	80	3"	309,00
NPT INIRP3PP04"FN	100	4"	346,00



COD.	Ø		Euro
	mm	inch	
BSP INIFRP3P1"12M	40	1"1/2	158,00
BSP INIFRP3P002"M	50	2"	159,00
BSP INIFRP3P03"AM	80	3"	193,00

COD.	Ø		Euro
	mm	inch	
NPT INIFRP3P1"12N	40	1"1/2	158,00
NPT INIFRP3P002"N	50	2"	159,00
NPT INIFRP3P03"AN	80	3"	193,00



IP/IP-F-RP3PP

uPVC

INCOLLAGGIO  
SOLV. CEMENT  
ENCOLAJE  
A' COLLER



COD.	Ø		Euro
	mm	inch	
ISO IPIRP3PP002"I	63		128,00
ISO IPIRP3PP03"AI	90		161,00
ISO IPIRP3PP03"FI	90		299,00
ISO IPIRP3PP04"FI	110		333,00

COD.	Ø		Euro
	inch		
ASTM IPIRP3PP002"W	2"		128,00
ASTM IPIRP3PP03"AW	3"		161,00
ASTM IPIRP3PP03"FW	3"		299,00
ASTM IPIRP3PP04"FW	4"		333,00



COD.	Ø		Euro
	mm	inch	
ISO IPIFRP3PP02"I	63		149,00
ISO IPIFRP3PP3"AI	90		183,00

COD.	Ø		Euro
	inch		
ASTM IPIFRP3PP02"W	2"		149,00
ASTM IPIFRP3PP3"AW	3"		183,00

Standard	Optionals
PN10	0,2÷1,5 bar
1,0÷5,5 bar	0,6÷3,0 bar
3-way	2,0÷9,0 bar



Funzioni Aggiuntive / Additional Functions / Funciones Adicionales / Fonctions Supplémentaires

IN/IP-RP3PP + CM4V

Comando manuale a 3 vie / 3-way manual handle  
Mando manual de 3 vías / Robinet 3 voies

Euro 19,00

IN/IP-RP3PP + EL

Solenoido 3 vie / 3-Way solenoid  
Solenoido de 3 vías / Solenoide 3 voies (24V AC PN10)

Euro 36,00

IN/IP-RP3PP + EL-BI

Solenoido bistabile / Latch solenoid  
Solenoido latch / Solenoide latch (9-12V DC PN10)

Euro 49,00

ООО «ТИ-СИСТЕМС» ИНЖИНИРИНГ И ПОСТАВКА ТЕХНОЛОГИЧЕСКОГО ОБОРУДОВАНИЯ

Интернет: www.tisys.ru www.tisys.kz www.tisys.by www.tesec.ru www.ti-sistems.pl

www.technik.com

TECNIDRO S.R.L.

Телефоны: +7 (495) 7774788, 7489626, 5007155, 54 Эл. почта: info@tisys.ru info@tisys.kz info@tisys.by



Controllo a Galleggiante / Float Control / Control de Flotador / Contrôle à Flotteur

Nylon/PP

	COD.	Ø		Euro		COD.	Ø		Euro
		mm	inch				mm	inch	
FILETTATO THREADED ROSCADO TARAUDE*	BSP INIGAL01*1/2M	40	1 1/2	189,00	NPT	INIGAL01*1/2N	40	1 1/2	189,00
	BSP INIGAL00002*M	50	2"	190,00	NPT	INIGAL00002*N	50	2"	190,00
	BSP INIGAL00003*AM	80	3"	224,00	NPT	INIGAL00003*AN	80	3"	224,00
	BSP INIGAL00003*FM	80	3"	360,00	NPT	INIGAL00003*FN	80	3"	360,00
	BSP INIGAL00004*FM	100	4"	397,00	NPT	INIGAL00004*FN	100	4"	397,00

uPVC

	COD.	Ø		Euro		COD.	Ø		Euro
		mm	inch				mm	inch	
INCOLLAGGIO SOLV. CEMENT ENCOLAJE A' COLLER	ISO IPIGAL00002*I	63		179,00	ASTM	IPIGAL00002*W	2"		179,00
	ISO IPIGAL00003*AI	90		212,00	ASTM	IPIGAL00003*AW	3"		212,00
	ISO IPIGAL00003*FI	90		350,00	ASTM	IPIGAL00003*FW	3"		350,00
	ISO IPIGAL00004*FI	110		384,00	ASTM	IPIGAL00004*FW	4"		384,00



IN-GAL / IP-GAL

Scarico Rapido / Quick Relief / Alivio Rápido / Décharge Rapide

Nylon/PP

	COD.	Ø		Euro		COD.	Ø		Euro
		mm	inch				mm	inch	
FILETTATO THREADED ROSCADO TARAUDE*	BSP INISR001*1/2M	40	1 1/2	154,00	NPT	INISR001*1/2N	40	1 1/2	154,00
	BSP INISR000002*M	50	2"	155,00	NPT	INISR000002*N	50	2"	155,00
	BSP INISR000003*AM	80	3"	189,00	NPT	INISR000003*AN	80	3"	189,00

uPVC

	COD.	Ø		Euro		COD.	Ø		Euro
		mm	inch				mm	inch	
INCOLLAGGIO SOLV. CEMENT ENCOLAJE A' COLLER	ISO IPISR000002*I	63		144,00	ASTM	IPISR000002*W	2"		144,00
	ISO IPISR00003*AI	90		177,00	ASTM	IPISR00003*AW	3"		177,00



IN-SR / IP-SR

Standard	Optionals
PN10	2,0÷9,0 bar
1,0÷5,5 bar	

Accessori / Accessories / Accesorios / Accessoires

Mod.	Tipo / Type / Tipo / Type	PN	Inch	COD.	Euro
CM4V	Rubinetto a 3 vie / 3-way manual handle / Mando manual de 3 vías / Robinet 3 voies	10	1/8"	RRACM4VO1/4*M	16,00
FILS	Filtro a sigaretta / Finger filter / Filtro de toma / Filtre a cigarette	10	1/8"	RRAFILSX1/4*M	9,00
EL	Solenoide plastica / plastic solenoid / Solenoide plástico / Solenoide plastique (3way-3W-N.O.-24VAC)	10	1/8"	REV3P1/8*3WNA	30,00
SHCM	Relé idraulico / Hydraulic relay / Relé hidráulico / Rélais hydraulique	10	Ø6x8	RRASHCM00060U	60,00
RP3PP	Riduttore di pressione / Pressure reducing	10	1/8"	RPIRP3PP02-15	75,00
" "	Reductor de presión / Réducteur de pression	10	1/8"	RPIRP3PP06-30	75,00
" "		10	1/8"	RPIRP3PP01-55	75,00
PROG	Programmatore a batteria / Battery controller / Programador de batería / Programmeur à piles	10	1/8"	RPROAUT9VDCBA	96,00
GAL	Galleggiante modulante / Modulating float / Flotador modulante / Flotteur modulante (Ø1/2")	10	1/2"	RPIGAL0001/2"	75,00



Raccordi rapidi / Push-in Fittings / Racores rápidos / Raccords rapides

COD.	Tipo / Type / Tipo / Type	Inch -  - x Ø	Euro
RRADRRP1/8*M6	Dritto / Connector / Recto / Droit	1/8" M Ø 6	1,20
RRADRRP1/8*M8	Dritto / Connector / Recto / Droit	1/8" M Ø 8	1,70
RRADRRP1/4*M6	Dritto / Connector / Recto / Droit	1/4" M Ø 6	1,30
RRADRRP1/4*M8	Dritto / Connector / Recto / Droit	1/4" M Ø 8	1,80
RRAGORP1/8*M6	Gomito / Elbow / Codo / Coude	1/8" M Ø 6	1,70
RRAGORP1/8*M8	Gomito / Elbow / Codo / Coude	1/8" M Ø 8	1,80
RRAGORP1/4*M6	Gomito / Elbow / Codo / Coude	1/4" M Ø 6	1,80
RRAGORP1/4*M8	Gomito / Elbow / Codo / Coude	1/4" M Ø 8	1,90
RRATERP1/8*M6	Tee / Tee / Te / Te	1/8" M Ø 6	1,80
RRATERP1/8*M8	Tee / Tee / Te / Te	1/8" M Ø 8	2,20
RRATERP1/4*M6	Tee / Tee / Te / Te	1/4" M Ø 6	1,90
RRATERP1/4*M8	Tee / Tee / Te / Te	1/4" M Ø 8	2,50
RRATACOP1/4*M	Tappo / Plug / Tapón / Bouchon	1/4" M -	0,70



Parti di Ricambio / Refill Parts / Repuestos / Pièces de Réchange

COD.	Sh	Size	Euro
RIMMEM113NR40	40	1 1/2" - 2" - 3"A	33,00
RIPMEM265NR60	60	3"F - 4"F	177,00
RIMMOL0203020	20	1 1/2" - 2" - 3"A	6,00
RIPMOL8010035	35	3"F - 4"F	42,00
RIMSUP002-003		1 1/2" - 2" - 3"A	5,00
RIPSUP080100		3"F - 4"F	15,00



Metering Systems

PN 16

TW-P  
Tangential

IST-S  
Istant flow

EMT  
Pulse emitter  
(Reed)

AW  
Woltmann

SEA  
Electromagnetic

Contatori Tangenziali / Tangential Water Meters / Contadores Tangenciales / Compteurs Tangentiels



TW-P

COD.	Ø		L mm	P kg	Q <sub>n</sub>		Euro		
	mm	inch			m <sup>3</sup> /h	l/s			
BSP	COITWPO02" M		50	2"	200	5.0	15.0	4.2	227,00
	COITWPO03" M		80	3"	225	8.0	40.0	11.1	231,00
FLANGED BRIDES	COITWPODN050F		50	2"	200	7.0	15.0	4.2	235,00
	COITWPODN065F		65	2½"	200	10.0	25.0	7.0	249,00
	COITWPODN080F		80	3"	225	12.0	40.0	11.1	264,00
	COITWPODN100F		100	4"	250	14.0	60.0	16.7	282,00
	COITWPODN125F		125	5"	250	18.0	100.0	27.8	419,00
	COITWPODN150F		150	6"	300	27.0	150.0	41.7	514,00
	COITWPODN200F		200	8"	350	41.0	250.0	69.4	666,00
	COITWPODN250F		250	10"	400	66.0	400.0	111.1	938,00
	COITWPODN300F		300	12"	500	85.0	600.0	166.7	1.238,00
	FLANGIATO BRIDADO								

Funzioni Aggiuntive / Additional Functions / Funciones Adicionales / Fonctions Supplémentaires

Standard	Optionals
ISO PN16	ISO PN10 ANSI 150 BS Table D



+ TW-E Versione ottone / Brass version (DN50 ÷ DN200) +Euro 38,00  
Tipo latón / Version en laiton

Accessori e Ricambi / Accessories & Refill Parts / Accesorios y Repuestos / Accessoires et Pièces de Réchange

Mod.	Tipo / Type / Tipo / Type	COD.	Euro	
<p>Batteria inclusa Battery included Bateria incluida Pile comprise</p> <p>Lithium</p> <p>IP68</p> <p>IST-C</p>	IST-C Indicatore di portata istantanea Compatto Compact instantaneous flow rate indicator Indicador de caudal instantáneo Compacto Indicateur de débit instantané Compact			
	1 PULSE x 100 L	RTWISTC0100L0	211,00	
	1 PULSE x 1.000 L	RTWISTC1000L0	211,00	
	1 PULSE x 100/1.000 L + Data Logger Output	----	----	
<p>Batteria inclusa Battery included Bateria incluida Pile comprise</p> <p>Lithium</p> <p>IP68</p> <p>IST-S</p>	IST-S Indicatore di portata istantanea Separato Separate instantaneous flow rate indicator Indicador de caudal instantáneo Separado Indicateur de débit instantané Separé			
	1 PULSE x 100 L	RTWISTS0100L0	244,00	
	1 PULSE x 1.000 L	RTWISTS1000L0	244,00	
	1 PULSE x 100/1.000 L + Data Logger Output	----	----	
<p>EMT</p>	EMT Emettitore d'impulsi / Reed contact switch Emisor de pulsos / Émetteur d'impulsions	RTWEMT0000000	52,00	
	<p>GR</p>	GR-TWP Meccanismo completo / Complete mechanism Mecanismo completo / Mécanisme complet	DN 50 ÷ 200 Dn250 ÷ 300	RTWPGR----- RTWPGR-----
		GR-TWE " " "	DN 50 ÷ 200	RTWEGR-----

COD.	Ø		L mm	P kg	Qn		AW Euro	AWZ CE Euro
	mm	inch			m³/h	l/s		
COIAWOODN050F	50	2"	200	12.0	15.0	4.2	242,00	429,00
COIAWOODN065F	65	2½"	200	13.0	25.0	7.0	253,00	446,00
COIAWOODN080F	80	3"	225	16.0	40.0	11.1	275,00	500,00
COIAWOODN100F	100	4"	250	16.5	60.0	16.7	297,00	544,00
COIAWOODN125F	125	5"	250	20.0	100.0	27.8	429,00	587,00
COIAWOODN150F	150	6"	300	42.0	150.0	41.7	671,00	1.123,00
COIAWOODN200F	200	8"	350	64.0	250.0	69.4	759,00	1.260,00
COIAWOODN250F	250	10"	450	94.0	400.0	111.1	1.364,00	1.724,00
COIAWOODN300F	300	12"	500	114.0	600.0	166.7	1.969,00	4.080,00
COIAWOODN400F	400	16"	600	199.0	1.000.0	277.8	6.424,00	
COIAWOODN500F	500	20"	800	340.0	1.500.0	416.7	7.943,00	



Standard  
ISO PN16

Optionals  
ISO PN10  
ANSI 150



Funzioni Aggiuntive / Additional Functions / Funciones Adicionales / Fonctions Supplémentaires

AW	+ EMT	Emettitore / Reed / Emisor / Eméteur	Euro	52,00
AW-Z	+ EMT	Emettitore / Reed / Emisor / Eméteur	Euro	80,00

Contatori a Getto Multiplo / Multijet Water Meters / Contadores de Chorro Multiple / Compteurs à Jet Multiple

Quadrante asciutto / Dry dial / Esfera seca / Cadran sec

COD.	Ø		L mm	Qn		Euro
	mm	inch		m³/h	l/s	
COIMWA001/2*M	15	1/2"	145	1.50	0.41	87,00
COIMWA003/4*M	20	3/4"	160	2.50	0.69	98,00
COIMWA00001*M	25	1"	260	3.50	0.97	165,00
COIMWA01*1/4M	32	1¼"	260	6.00	1.67	191,00
COIMWA01*1/2M	40	1½"	300	10.0	2.78	272,00
COIMWA00002*M	50	2"	300	15.0	4.17	291,00

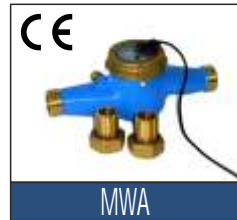
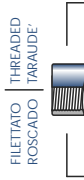

Standard  
BSP

Optionals  
NPT

MWA	+ EMT	Emettitore / Reed / Emisor / Eméteur	Euro	87,00
-----	-------	--------------------------------------	------	-------

Contatori a Sella / Saddle Water Meters / Contadores de Sileta / Compteurs à Selle

COD.	Ø		L mm	Qn		Euro
	mm	inch		m³/h	l/s	
COITWSEDN150F	150	6"	230	150.0	41.7	-----
COITWSEDN200F	200	8"	250	250.0	69.4	-----
COITWSEDN250F	250	10"	265	400.0	111.1	-----
COITWSEDN300F	300	12"	310	600.0	167.1	-----

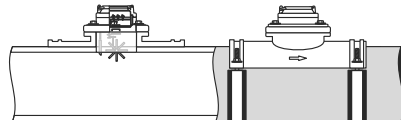

Misuratori Elettromagnetici / Electromagnetic Flow-Meter / Medidor Electro-Magnético / Débitmètre Electromagnétique

COD.	Ø		L mm	Qn l/s	SEA	SEA-BT
	mm	inch			Euro	Euro
COISEA0DN050F	50	2"	200	0,10 ÷ 25,61	1.360,00	3.480,00
COISEA0DN065F	65	2½"	200	0,16 ÷ 39,72	1.395,00	3.520,00
COISEA0DN080F	80	3"	200	0,25 ÷ 60,27	1.470,00	3.590,00
COISEA0DN100F	100	4"	250	0,40 ÷ 94	1.540,00	3.670,00
COISEA0DN125F	125	5"	250	0,60 ÷ 147	1.680,00	3.805,00
COISEA0DN150F	150	6"	300	0,90 ÷ 212	1.790,00	3.910,00
COISEA0DN200F	200	8"	350	1,60 ÷ 377	2.005,00	4.130,00
COISEA0DN250F	250	10"	400	2,50 ÷ 589	2.505,00	4.630,00
COISEA0DN300F	300	12"	500	3,50 ÷ 848	3.145,00	5.270,00
COISEA0DN350F	350	14"	500	5,00 ÷ 1.154	3.430,00	5.555,00
COISEA0DN400F	400	16"	600	6,00 ÷ 1.507	3.890,00	6.015,00
COISEA0DN450F	450	18"	600	8,00 ÷ 1.908	4.370,00	6.495,00
COISEA0DN500F	500	20"	600	10,00 ÷ 2.355	5.140,00	7.265,00
COISEA0DN600F	600	24"	600	14,00 ÷ 3.391	5.790,00	7.910,00
DN600 - 24" ÷ DN2.000 - 80" PN10/PN6					-----	-----



Funzioni Aggiuntive / Additional Functions / Funciones Adicionales / Fonctions Supplémentaires



SEA	+ RD	Visualizzatore remoto / Remote display / Pantalla remota / Afficheur séparé	Euro	210,00
-----	------	---	------	--------

Gates, Air, Check Valves & Strainers

PN 10/16



Saracinesca a Cuneo Gommato / Resilient Seat Gate Valve / Compuerta de Cierre Elástico / Vanne Opercule Caoutchouc



SAR F4

COD.	Ø		Euro
	mm	inch	
SARCF4DN040	40	1½"	117,00
SARCF4DN050	50	2"	121,00
SARCF4DN065	65	2½"	149,00
SARCF4DN080	80	3"	186,00
SARCF4DN100	100	4"	232,00
SARCF4DN125	125	5"	313,00
SARCF4DN150	150	6"	394,00
SARCF4DN200	200	8"	605,00
SARCF4DN250	250	10"	947,00
SARCF4DN300	300	12"	1.361,00
Ø 350-800 (14"-32")	-----		-----



SAR F5

COD.	Ø		Euro
	mm	inch	
SARCF5DN040	40	1½"	123,00
SARCF5DN050	50	2"	129,00
SARCF5DN065	65	2½"	162,00
SARCF5DN080	80	3"	194,00
SARCF5DN100	100	4"	257,00
SARCF5DN125	125	5"	343,00
SARCF5DN150	150	6"	430,00
SARCF5DN200	200	8"	675,00
SARCF5DN250	250	10"	1.085,00
SARCF5DN300	300	12"	1.564,00
Ø 350-800 (14"-32")	-----		-----



SAV

Incluso  
Included  
Incluydo  
Inclus

Standard    Optionals

ISO PN16

ISO PN10

ANSI 150

BS Table D



Sfiato / Air Valve / Válvula de aire / Ventouse



SFI SINGLE

COD.	Ø		Euro
	mm	inch	
SFISNGDN040	40	1½"	135,00
SFISNGDN050	50	2"	151,00
SFISNGDN065	65	2½"	168,00
SFISNGDN080	80	3"	203,00
SFISNGDN100	100	4"	254,00
SFISNGDN125	125	5"	264,00
SFISNGDN150	150	6"	421,00



SFI SIMPLE

COD.	Ø		Euro
	mm	inch	
SFISMPLODN040	40	1½"	174,00
SFISMPLODN050	50	2"	174,00
SFISMPLODN065	65	2½"	174,00



SFI DOUBLE

COD.	Ø		Euro
	mm	inch	
SFIDBLDN040	40	1½"	157,00
SFIDBLDN050	50	2"	187,00
SFIDBLDN065	65	2½"	199,00
SFIDBLDN080	80	3"	225,00
SFIDBLDN100	100	4"	273,00
SFIDBLDN125	125	5"	438,00
SFIDBLDN150	150	6"	451,00
SFIDBLDN200	200	8"	734,00
SFIDBLDN250	250	10"	1.052,00



SFI INTERFL

COD.	Ø		Euro
	mm	inch	
SFINTFLDN080	80	2"	200,00
SFINTFLDN100	100	2½"	205,00



Standard

ISO PN16

Optionals

ISO PN10

ANSI 150

BS Table D

Valvola di ritegno

/ Check Valve / Válvula de Retención / Vanne Anti-rétour



CHECK

COD.	Ø		Euro
	mm	inch	
CHECKDN050	50	2"	164,00
CHECKDN065	65	2½"	197,00
CHECKDN080	80	3"	242,00
CHECKDN100	100	4"	319,00
CHECKDN125	125	5"	416,00
CHECKDN150	150	6"	541,00
CHECKDN200	200	8"	779,00
CHECKDN250	250	10"	1.403,00
CHECKDN300	300	12"	1.891,00



FILTERY

COD.	Ø		Euro
	mm	inch	
FILTERYDN050	50	2"	107,00
FILTERYDN065	65	2½"	149,00
FILTERYDN080	80	3"	180,00
FILTERYDN100	100	4"	254,00
FILTERYDN125	125	5"	355,00
FILTERYDN150	150	6"	552,00
FILTERYDN200	200	8"	856,00
FILTERYDN250	250	10"	1.635,00
FILTERYDN300	300	12"	2.161,00



Standard    Optionals

ISO PN16

ISO PN10

ANSI 150

ООО «ТИСИСТЕМС» ИНЖИНИРИНГ И ПОСТАВКА ТЕХНОЛОГИЧЕСКОГО ОБОРУДОВАНИЯ

Интернет: [www.tisys.ru](http://www.tisys.ru) [www.tisys.kz](http://www.tisys.kz) [www.tisys.by](http://www.tisys.by) [www.tesec.ru](http://www.tesec.ru) [www.ti-sistems.pl](http://www.ti-sistems.pl)

[www.technikro.com](http://www.technikro.com)

TECNIDRO S.R.L.

## Butterfly &amp; Needle Valves

PN 10/16



## Valvole a Farfalla Doppio Eccentrico

/ Double Eccentric Butterfly Valves / Válvulas de Mariposa Dobles Excéntricas  
/ Vannes Papillon Double Excentrique

PN10	COD.	Ø		Euro	
		mm	inch		
FLANGED BRIDES	BUTDBLD10100F	100	4"	767,00	
	BUTDBLD10125F	125	5"	878,00	
	BUTDBLD10150F	150	6"	893,00	
	BUTDBLD10200F	200	8"	1.075,00	
	BUTDBLD10250F	250	10"	1.252,00	
	BUTDBLD10300F	300	12"	1.703,00	
	BUTDBLD10350F	350	14"	2.254,00	
	BUTDBLD10400F	400	16"	2.974,00	
	BUTDBLD10450F	450	18"	3.675,00	
	BUTDBLD10500F	500	20"	4.580,00	
FLANGIATO BRIDADO	BUTDBLD10550F	550	22"	5.281,00	
	BUTDBLD10600F	600	24"	5.982,00	
	BUTDBLD10650F	650	26"	7.220,00	
	BUTDBLD10700F	700	28"	8.491,00	
	BUTDBLD10750F	750	30"	9.192,00	
	BUTDBLD10800F	800	32"	9.894,00	
	BUTDBLD10900F	900	36"	12.364,00	
	Ø 1000-2000 (40"-80")				-----

PN16	COD.	Ø		Euro	
		mm	inch		
FLANGED BRIDES	BUTDBLD16100F	100	4"	807,00	
	BUTDBLD16125F	125	5"	878,00	
	BUTDBLD16150F	150	6"	896,00	
	BUTDBLD16200F	200	8"	1.131,00	
	BUTDBLD16250F	250	10"	1.318,00	
	BUTDBLD16300F	300	12"	1.793,00	
	BUTDBLD16350F	350	14"	2.373,00	
	BUTDBLD16400F	400	16"	3.131,00	
	BUTDBLD16450F	450	18"	3.869,00	
	BUTDBLD16500F	500	20"	4.821,00	
FLANGIATO BRIDADO	BUTDBLD16550F	550	22"	5.559,00	
	BUTDBLD16600F	600	24"	6.296,00	
	BUTDBLD16650F	650	26"	7.600,00	
	BUTDBLD16700F	700	28"	8.938,00	
	BUTDBLD16750F	750	30"	9.676,00	
	BUTDBLD16800F	800	32"	10.414,00	
	BUTDBLD16900F	900	36"	13.014,00	
	Ø 1000-2000 (40"-80")				-----



BUT DOUBLE

Standard

Gearbox  
Handwheel

## Funzioni Aggiuntive / Additional Functions / Funciones Adicionales / Fonctions Supplémentaires



BUT-DBLD + MOT Motorizzata / Motorized / Motorizada / Motorisé

Euro -----

## Valvola a Fusso / Needle Valve / Valvula de Paso Anular / Vanne Annulaire

PN16	COD.	Ø		Euro
		mm	inch	
FLANGED BRIDES	NDLE16DN0100F	100	4"	4.028,00
	NDLE16DN0150F	150	6"	6.318,00
	NDLE16DN0200F	200	8"	9.310,00
	NDLE16DN0250F	250	10"	12.491,00
	NDLE16DN0300F	300	12"	15.461,00
	NDLE16DN0350F	350	14"	17.751,00
	NDLE16DN0400F	400	16"	25.067,00
	NDLE16DN0450F	450	18"	28.598,00
	NDLE16DN0500F	500	20"	31.636,00
	NDLE16DN0600F	600	24"	39.869,00
FLANGIATO BRIDADO	Ø 700-1200 (28"-48") -----			



Optional



NEEDLE

## Funzioni Aggiuntive / Additional Functions / Funciones Adicionales / Fonctions Supplémentaires



NDLE + MOT Motorizzata / Motorized / Motorizada / Motorisé

Euro -----

ООО «ТИ-СИСТЕМС» ИНЖИНИРИНГ И ПОСТАВКА ТЕХНОЛОГИЧЕСКОГО ОБОРУДОВАНИЯ

Интернет: www.tisys.ru www.tisys.kz www.tisys.by www.tesec.ru www.ti-sistems.pf

TECNIDRO S.R.L. Телефоны: +7 (495) 7774788, 7489626, 5007155, 54 Эл. почта: info@tisys.ru info@tisys.kz info@tisys.by



RRA-OG

COD.	Tipo / Type / Tipo / Type	Inch - 	X Ø	Euro
RRADR1/8"MR08	Dritto / Connector / Recto / Droit	1/8"	M Ø 8	2,80
RRADR1/8"FR08	Dritto / Connector / Recto / Droit	1/8"	F Ø 8	2,20
RRADR1/4"MR08	Dritto / Connector / Recto / Droit	1/4"	M Ø 8	3,00
RRADR1/4"FR08	Dritto / Connector / Recto / Droit	1/4"	F Ø 8	2,30
RRADR1/4"MR10	Dritto / Connector / Recto / Droit	1/4"	M Ø 10	4,80
RRADR1/4"FR10	Dritto / Connector / Recto / Droit	1/4"	F Ø 10	3,50
RRAGO1/8"MR08	Gomitolo / Elbow / Codo / Coude	1/8"	M Ø 8	3,00
RRAGO1/4"MR08	Gomitolo / Elbow / Codo / Coude	1/4"	M Ø 8	3,10
RRAGO1/4"MR10	Gomitolo / Elbow / Codo / Coude	1/4"	M Ø 10	4,60
RRATE1/8"MR08	Tee / Tee / Te / Te	1/8"	M Ø 8x8	4,60
RRATE1/4"MR08	Tee / Tee / Te / Te	1/4"	M Ø 8x8	4,60
RRATE1/4"MR10	Tee / Tee / Te / Te	1/4"	M Ø 10x10	7,80

Raccordi Standard / Standard Fittings / Racores Estándar / Raccords Standard



RRA-ST

COD.	Tipo / Type / Tipo / Type	Inch - 	Euro
RRANI1/8"1/8"	Nippolo / Nipple / Niple / Mamelon	1/8"	M-M 0,80
RRANI1/4"1/4"	Nippolo / Nipple / Niple / Mamelon	1/4"	M-M 1,20
RRANI1/2"1/2"	Nippolo / Nipple / Niple / Mamelon	1/2"	M-M 2,80
RRANR1/4"1/8"	Nippolo rid. / Red. nipple / Niple red. / Mamelon red.	1/4"-1/8"	M-M 1,20
RRANR3/8"1/4"	Nippolo rid. / Red. nipple / Niple red. / Mamelon red.	3/8"-1/4"	M-M 1,60
RRANR1/2"1/4"	Nippolo rid. / Red. nipple / Niple red. / Mamelon red.	1/2"-1/4"	M-M 2,70
RRAMA1/8F1/8F	Manicotto / Straight / Manguito / Manchon	1/8"	F-F 1,20
RRAMA1/4F1/4F	Manicotto / Straight / Manguito / Manchon	1/4"	F-F 1,60
RRAMA1/2F1/2F	Manicotto / Straight / Manguito / Manchon	1/2"	F-F 4,00
RRAMR1/2F1/4F	Manicotto / Straight / Manguito / Manchon	1/2"-1/4"	F-F 3,00
RRAMR3/4F1/2F	Manicotto / Straight / Manguito / Manchon	3/4"-1/2"	F-F 9,20
RRARI1/8M1/8F	Riduzione / Reducer / Reducción / Réduction	1/8"-1/8"	M-F 1,10
RRARI1/8M1/4F	Riduzione / Reducer / Reducción / Réduction	1/8"-1/4"	M-F 1,40
RRARI1/4M1/4F	Riduzione / Reducer / Reducción / Réduction	1/4"-1/4"	M-F 1,60
RRARI1/4M1/2F	Riduzione / Reducer / Reducción / Réduction	1/4"-1/2"	M-F 3,80
RRARI1/4M3/8F	Riduzione / Reducer / Reducción / Réduction	1/4"-3/8"	M-F 2,40
RRARI3/8M1/4F	Riduzione / Reducer / Reducción / Réduction	3/8"-1/4"	M-F 1,20
RRARI1/2M1/4F	Riduzione / Reducer / Reducción / Réduction	1/2"-1/4"	M-F 2,00
RRARI3/4M1/4F	Riduzione		
RRA3/4M1/2F	Riduzione / Reducer / Reducción / Réduction	3/4"-1/2"	M-F 6,50
RRAGO1/8M1/8F	Gomitolo / Elbow / Codo / Coude	1/8"	M-F 2,10
RRAGO1/8F1/8F	Gomitolo / Elbow / Codo / Coude	1/8"	F-F 2,20
RRAGO1/4M1/4F	Gomitolo / Elbow / Codo / Coude	1/4"	M-F 2,90
RRAGO1/4F1/4F	Gomitolo / Elbow / Codo / Coude	1/4"	F-F 3,10
RRATE1/8"-MMF	Tee / Tee / Te / Te	1/8"	M-M-F 2,80
RRATE1/8"-FMF	Tee / Tee / Te / Te	1/8"	F-M-F 2,70
RRATE1/8"-FFM	Tee / Tee / Te / Te	1/8"	F-F-M 2,70
RRATE1/8"-FFF	Tee / Tee / Te / Te	1/8"	F-F-F 2,60
RRATE1/4"-MMF	Tee / Tee / Te / Te	1/4"	M-M-F 3,90
RRATE1/4"-FMF	Tee / Tee / Te / Te	1/4"	F-M-F 3,70
RRATE1/4"-FFM	Tee / Tee / Te / Te	1/4"	F-F-M 3,70
RRATE1/4"-FFF	Tee / Tee / Te / Te	1/4"	F-F-F 3,70
RRACR1/4"MMMM	Croce / Cross / Cruz / Croix	1/4"	M-F-F-F 5,70
RRAPR1/8M1/8F	Prolunga / Extention / Extensión / Allonge (42 mm)	1/8"	M-F 2,50
RRAPR1/4M1/4F	Prolunga / Extention / Extensión / Allonge (51 mm)	1/4"	M-F 3,60
RRATACON1/8"M	Tappo / Plug / Tapón / Bouchon	1/8"	M-F 0,80
RRATACON1/4"M	Tappo / Plug / Tapón / Bouchon	1/4"	M-F 0,90

Tubi / Tubing / Tubos / Tuyaux



TU-PE

TU-RA

TU-IX

COD.	Tipo / Type / Tipo / Type	PN	Ø	Mt.	Euro
RRATUPEAD0604	PEAD nero / Black PEHD / PEAD negro / PEHD noir	16	Ø 6	100,0	79,00
RRATUPEAD0806	PEAD nero / Black PEHD / PEAD negro / PEHD noir	16	Ø 8	100,0	113,00
RRATURAME0008	Rame / Copper / Cobre / Cuivre	25	Ø 8	1,0	12,00
RRATURAME0010	Rame / Copper / Cobre / Cuivre	25	Ø 10	1,0	16,00
RRATUINOX0008	Inox / Stainless Steel / Inoxidable / Inoxydable	25	Ø 8	1,0	18,00
RRATUINOX0010	Inox / Stainless Steel / Inoxidable / Inoxydable	25	Ø 10	1,0	30,00

ООО «ТИ-СИСТЕМС» ИНЖИНИРИНГ И ПОСТАВКА ТЕХНОЛОГИЧЕСКОГО ОБОРУДОВАНИЯ

Интернет: [www.tisys.ru](http://www.tisys.ru) [www.tisys.kz](http://www.tisys.kz) [www.tisys.by](http://www.tisys.by) [www.tesec.ru](http://www.tesec.ru) [www.ti-sistems.pl](http://www.ti-sistems.pl)

[www.technikro.com](http://www.technikro.com)

TECNIDRO S.R.L.

Телефоны: +7 (495) 7774788, 7489626, 5007155, 54 Эл. почта: [info@tisys.ru](mailto:info@tisys.ru) [info@tisys.kz](mailto:info@tisys.kz) [info@tisys.by](mailto:info@tisys.by)

#### TERMINI e CONDIZIONI DI VENDITA

La vendita di tutti i prodotti presenti nel Listino Prezzi è subordinata all'accettazione delle Condizioni Generali di Vendita pubblicate sul sito [www.tecnidro.com](http://www.tecnidro.com), che possono essere visualizzate e scaricate al seguente collegamento: [www.tecnidro.com/dwl/condizioni-vendita.pdf](http://www.tecnidro.com/dwl/condizioni-vendita.pdf)

#### SALE'S TERMS and CONDITIONS

The sale of all products listed in the Price List is subject to acceptance of the General Terms and Conditions of Sale posted on the website [www.tecnidro.com](http://www.tecnidro.com), which can be viewed and downloaded at the following link: [www.tecnidro.com/dwl/condizioni-vendita.pdf](http://www.tecnidro.com/dwl/condizioni-vendita.pdf)

#### TERMES et CONDITIONS DE VENTE

La vente de tous les produits affichés dans la Liste de Prix est conditionnée par l'acceptation des Termes et Conditions Générales de Vente affichés sur le site [www.tecnidro.com](http://www.tecnidro.com), qui peut être consulté et téléchargé au lien suivant : [www.tecnidro.com/dwl/condizioni-vendita.pdf](http://www.tecnidro.com/dwl/condizioni-vendita.pdf)

#### TERMINOS y CONDICIONES DE VENTA

La venta de todos los productos enumerados en la Lista de Precios está condicionada a la aceptación de los Términos y Condiciones Generales de Venta publicados en el sitio [www.tecnidro.com](http://www.tecnidro.com), que se pueden consultar y descargar al siguiente enlace: [www.tecnidro.com/dwl/condizioni-vendita.pdf](http://www.tecnidro.com/dwl/condizioni-vendita.pdf)



TECNIDRO S.R.L.

*UNI EN ISO 9001:2008*  
*UNI EN ISO 14001:2004*

ООО «ТИ-СИСТЕМС» ИНЖИНИРИНГ И ПОСТАВКА ТЕХНОЛОГИЧЕСКОГО ОБОРУДОВАНИЯ  
Интернет: [www.tisys.ru](http://www.tisys.ru) [www.tisys.kz](http://www.tisys.kz) [www.tisys.by](http://www.tisys.by) [www.tesec.ru](http://www.tesec.ru) [www.ти-системс.рф](http://www.ти-системс.рф)  
Телефоны: +7 (495) 7774788, 7489626, 5007155, 54 Эл. почта: [info@tisys.ru](mailto:info@tisys.ru) [info@tisys.kz](mailto:info@tisys.kz) [info@tisys.by](mailto:info@tisys.by)

